



A·E·L

ELECTRICAL - MECHANICAL - SCALES



2025

PRODUCT CATALOGUE

A·E·L

ELECTRICAL - MECHANICAL - SCALES



ABOUT US

A QUARTER-CENTURY OF EXPERIENCE

AEL was founded in 1998 as an electrical business primarily focused on food production factories.

We are now a diverse engineering company focused on the industrial sector of New Zealand providing repair, install and fault finding in the electrical, mechanical and scales servicing and calibration fields and providing new equipment to service the cementitious materials, aggregates, food and chemical industries.

We have a large range of products available from our industry leading partners, no matter your problem we likely have the solution for you.

We currently service nationwide with service centres in Northland, Auckland, Waikato, and Canterbury.

Check out our full range of services online at allwest.co.nz





Ozbekoglu was founded in 1974 and began its activities in wholesales of consumer products. In 1992, the company entered the industrial equipment market in which it still operates. The main area of activity is supplying of equipment for handling, mixing and transfer of bulk solids.

In addition to product supply, the company provides complete solutions for its customers by offering all services required in engineering, pre-sales and after-sales. Conscious of the impossibility of providing a single solution for all customers, due to many different equipment and applications in the market; Ozbekoglu, holder of ISO 9001, ISO 14001, ISO 45001 and CE certificates, is able to provide a specific solution for each customer thanks to its know-how in utilizing standard components in systems created for different applications.

After entering the industrial equipment market in 1992 by supplying imported goods Ozbekoglu established its production facility in Ankara in 2009 on a total area of 194.000 ft², where it continues to produce standardized products according to customer needs.

Having adopted the philosophy of production without compromising quality, Ozbekoglu focuses its services on system solutions and providing of specific products for special requirements.

Some of the products supplied by Ozbekoglu facilities are; screw conveyors, filters and accessories, butterfly valves, slide valves, actuators, pressure relief valves, level indicators, fluidization nozzles, rotary valves, loading bellows, bin activators, micro dosing units, pinch valve, concrete reclaimer system, big bag unloading unit, manual bag opening station, mobile tanker loading system, vibrators, capacitive and microwave moisture probes and batch control meters.

Through direct and indirect sales, Ozbekoglu products have reached customers all over the world where their quality and efficiency have been appreciated. In accordance with its goal of becoming a global brand, the company has phased in its export activities through its dealer network in Europe, Middle East and America sparing no effort to establish its quality in products and services.

Since January 2017 we opened our newest branch in the Atlanta, Georgia area as OZB USA. Our branch office in Atlanta becomes fully functional with our professional sales team.



Filter

Pressure Relief Valve

Level Indicator

Fluidisation Nozzles

Butterfly Valve

Manual Arm

Screw Conveyor

CONTENTS

SCREW CONVEYOR	6	RV ROTARY VALVES (DROP THROUGH)	65
SCS SCREW CONVEYOR	7	RV OPTIONS	66
SCS SCREW CONVEYORS WITH DRIVE GROUP	8	RV SPARE PARTS	68
SCSR SCREW CONVEYOR	11	PNV PINCH VALVES	69
SCS OPTIONS FOR INLET AND OUTLET	15	LP LEVEL INDICATORS	70
SCS OPTIONS FOR DRIVE GROUP	19	LP OPTIONS	71
SC ACCESSORIES	21	AJ FLUIDISATION NOZZLES	73
SCS SPARE PARTS	23	SEC BIN ACTIVATORS	75
AIRFILL	26	SEC CARBON STEEL BIN ACTIVATORS	76
AIRFILL DUST-PRO 18 FILTER	27	SEC STAINLESS STEEL BIN ACTIVATORS	77
AIRFILL FILTERS	28	SEC OPTIONS	78
HOPPERFILL FILTER	30	SEC OPTIONS	79
AIRFILL OPTIONS	31	SEC SPARE PARTS	80
AIRFILL V VIBRATING FILTERS	33	BBU BIG BAG UNLOADING UNIT	81
POLYFIL 90 FILTER	34	BBU OPTIONS	82
AIRFILL SPARE PARTS	36	BBU ACCESSORIES	84
AIRFILL SPARE PARTS	37	BBU SPARE PARTS	86
FH HOPPER	38	MBOS - MANUAL BAG OPENING SYSTEM	87
FHR HOPPER FOR AIRFILL FILTERS	39	MBOS OPTIONS	88
PV PRESSURE RELIEF VALVE	40	MBOS ACCESSORIES	89
PV OPTIONS	41	MBOS SPARE PARTS	90
PV SPARE PARTS	43	LB - LOADING BELLOW	91
MPG4 MECHANICAL PRESSURE GAUGE	45	LB FOR SILOBUS LOADING	92
BV BUTTERFLY VALVES	47	LB FOR SILOBUS LOADING	93
BV OPTIONS	48	LB FOR SILOBUS LOADING WITH FILTER	94
BV ACTUATORS	49	LB FOR SILOBUS LOADING WITH FILTER	95
BVFF BUTTERFLY VALVES	50	LB FOR OPEN TRUCK LOADING	96
BVFF BUTTERFLY VALVES AND ACTUATOR	51	LB FOR OPEN TRUCK LOADING	97
BV SPARE PARTS	52	LB FOR OPEN TRUCK LOADING WITH FILTER	98
BV SPARE PARTS	53	LB FOR OPEN TRUCK LOADING WITH FILTER	99
SLIDE VALVES	55	LB SPARE PARTS	100
SVQ SQUARE SECTION SLIDE VALVES	56	MTLS - MOBILE TANKER LOADING SYSTEM	101
SVC ROUND SECTION SLIDE VALVES	57	MTLS OPTIONS	102
SVC RECTANGULAR SECTION SLIDE VALVES	58	MTLS SPARE PARTS	103
SV OPTIONS	59	NOTES	104
SV ACTUATORS	60		
SV ACTUATORS	61		
SV SPARE PARTS	62		

SCREW CONVEYOR



1	2	3	4	5	6	7	8	9
SCS	273	8000	HBR130	7	11	300	C	22

1 Screw conveyor type

SCS Screw conveyor for cement in batching plants within standardized configuration

2 Nominal outer pipe diameter

114 - 323mm

3 Length
From inlet centre to outlet centre

According to diameter;
1.000mm - 20.000mm

4 Gearbox type

According to screw conveyor type
HBR, HBRD, HBRV, FA, MHE, P, ...

5 Gear ratio

According to Screw Conveyor Type
1/5, 1/7, 1/10

6 Electric Motor

kW	Motor power
X	Electric motor excluded

7 Inlet Type

C Cylindrical and without flange

8 Outlet type

XXX Universal inlet with flange for XXXmm butterfly valve

9 Inclination of screw conveyor

0- 44°

SCS	SCREW CONVEYOR FOR CEMENT IN BATCHING PLANTS WITHIN STANDARDIZED CONFIGURATION	
------------	---	--

Specifications	Standard Configuration	Option
Outer Pipe Diameter:	114, 139, 168, 193, 219, 273, 323 mm	None
Inlet:	114 & 139mm: Cylindrical inlet without flange 168 & 193mm: universal inlet and flange for 200mm butterfly valve 219mm: universal inlet and flange for 250mm butterfly valve 273 & 323mm: universal inlet and flange for 300mm butterfly valve	None
Outlet:	Cylindrical outlet without flange	None
Additional Inlet & Outlet:	None	None
Inlet End Bearing:	None	None
Outlet End Bearing:	SCEB	None
Hanger Bearing:	SCIB	None
Flight:	Standard	None
Shaft:	Standard	None
Drive Group Position:	Inlet side	None
Inspection Hatch:	Fully cover with EPDM, available as standard under the inlet and hanger bearings.	None
Gearbox:	HBR	None
Gear Ratio:	114 & 139 & 168 & 193 & 219mm: 1/5 273mm: 1/7 323mm: 1/10	None
Electric Motor:	△230 / Y 400V 50 Hz < 4kW △400 / Y 690V 50 Hz ≥ 4kW Efficiency class: IE3 Protection class: IP 55 Insulation class: F (155 °C)	None
Inclination:	30°	None
Finishing:	Sand blasted and powder coated nominal 80 microns in caterpillar yellow for conveyor housing.	None
Accessories:	None	Available
Tungsten-carbide coating on flight edges:	None	None
Reversible:	None	None
Distributing:	None	None
Collecting:	None	None
Injection:	None	None
WHB Without Hanger Bearing:	None	None

SCS SCREW CONVEYORS WITH DRIVE GROUP

Length mm	SCS 114 (4 ton/h)		SCS 139 (5 ton/h)		SCS 168 (25 ton/h)	
	Drive Group	Price	Drive Group	Price	Drive Group	Price
1.000	HBRD82/5/2,2	\$2,775.50	HBRD82/5/2,2	\$3,115.84	HBR 82/5/3	\$3,672.76
1.500	HBRD82/5/2,2	\$2,780.96	HBRD82/5/2,2	\$3,270.54	HBR 82/5/3	\$3,856.58
2.000	HBRD82/5/2,2	\$2,904.72	HBRD82/5/2,2	\$3,419.78	HBR 82/5/3	\$4,007.64
2.500	HBRD82/5/2,2	\$3,032.12	HBRD82/5/2,2	\$3,569.02	HBR 82/5/3	\$4,659.20
3.000	HBRD82/5/2,2	\$3,159.52	HBRD82/5/2,2	\$3,718.26	HBR 82/5/4	\$4,440.80
3.500	HBRD82/5/2,2	\$3,286.92	HBRD82/5/2,2	\$3,867.50	HBR 82/5/4	\$4,591.86
4.000	HBRD82/5/2,2	\$4,116.84	HBRD82/5/2,2	\$4,220.58	HBR 82/5/4	\$5,132.40
4.500	HBRD82/5/2,2	\$4,264.26	HBRD82/5/2,2	\$4,369.82	HBR 82/5/4	\$5,272.54
5.000	HBRD82/5/2,2	\$4,409.86	HBRD82/5/3	\$4,546.36	HBR 82/5/4	\$5,401.76
5.500	HBRD82/5/2,2	\$4,551.82	HBRD82/5/3	\$4,668.30	HBR 82/5/4	\$5,780.32
6.000	HBRD82/5/2,2	\$4,699.24	HBRD82/5/3	\$4,817.54	HBR 100/5/4	\$6,016.92
6.500	HBRD82/5/2,2	\$4,844.84	HBRD82/5/3	\$5,001.36	HBR 100/5/4	\$6,211.66
7.000	HBRD82/5/2,2	\$5,241.60	HBRD82/5/4	\$5,907.72	HBR 100/5/5,5	\$7,238.14
7.500	HBRD82/5/2,2	\$5,383.56	HBRD82/5/4	\$6,042.40	HBR 100/5/5,5	\$7,378.28
8.000	HBRD82/5/2,2	\$5,532.80	HBRD82/5/4	\$6,198.92	HBR 100/5/5,5	\$7,509.32
8.500	HBRD82/5/2,2	\$5,734.82	HBRD82/5/4	\$6,562.92	HBR 100/5/5,5	\$7,627.62
9.000	HBRD82/5/2,2	\$5,884.06	HBRD82/5/4	\$6,865.04	HBR 100/5/5,5	\$7,767.76
9.500	HBRD82/5/3	\$6,178.90	HBRD82/5/4	\$7,083.44	HBR 100/5/5,5	\$7,962.50
10.000	HBRD82/5/3	\$6,739.46	HBRD82/5/4	\$7,531.16	HBR 100/5/7,5	\$8,264.62
10.500	HBRD82/5/3	\$6,926.92	HBRD82/5/4	\$8,219.12	HBR 100/5/7,5	\$8,912.54
11.000	HBRD82/5/3	\$7,123.48	HBRD82/5/4	\$8,437.52	HBR 100/5/7,5	\$9,172.80
11.500	HBRD82/5/3	\$7,280.00	HBRD82/5/4	\$8,604.96	HBR 100/5/7,5	\$9,398.48
12.000	HBRD82/5/3	\$7,389.20	HBRD82/5/4	\$8,708.70	HBR 100/5/7,5	\$9,582.30
12.500	HBRD82/5/3	\$7,684.04	HBRD82/5/4	\$8,887.06	HBR 100/5/7,5	\$9,864.40
13.000	HBRD82/5/3	\$8,215.48	HBRD82/5/4	\$9,751.56	HBR 100/5/7,5	\$10,361.26
13.500					HBR 100/5/7,5	\$10,534.16
14.000					HBR 100/5/7,5	\$10,717.98
14.500					HBR 100/5/7,5	\$11,234.86
15.000					HBR 100/5/7,5	\$11,578.84
15.500					HBR 100/5/7,5	\$11,815.44
16.000					HBR 130/5/9,2	\$12,099.36
16.500					HBR 130/5/9,2	\$12,266.80
17.000					HBR 130/5/9,2	\$12,372.36
17.500					HBR 130/5/9,2	\$12,647.18
18.000					HBR 130/5/9,2	\$12,831.00
Included:	Ø114mm cylindrical inlet without flange		Ø139mm cylindrical inlet without flange		Universal inlet with flange for 200mm butterfly valve	

NOTE: The given capacities are the nominal values for Portland Cement with 1,13 t/m³ density and normal operating conditions. And it will differ according to material fluidity and feeding method.

SCS SCREW CONVEYORS WITH DRIVE GROUP

Length mm	SCS 193 (40 ton/h)		SCS 219 (60 ton/h)		SCS 273 (90 ton/h)	
	Drive Group	Price	Drive Group	Price	Drive Group	Price
1.000	HBR 82/5/4	\$3,996.72	HBR 100/5/5,5	\$4,304.30	HBR 100/7/5,5	\$4,573.66
1.500	HBR 82/5/4	\$4,158.70	HBR 100/5/5,5	\$4,651.92	HBR 100/7/5,5	\$4,848.48
2.000	HBR 82/5/4	\$4,331.60	HBR 100/5/5,5	\$4,808.44	HBR 100/7/5,5	\$5,083.26
2.500	HBR 82/5/4	\$4,537.26	HBR 100/5/5,5	\$4,959.50	HBR 100/7/5,5	\$5,347.16
3.000	HBR 82/5/4	\$4,721.08	HBR 100/5/5,5	\$5,112.38	HBR 100/7/5,5	\$5,581.94
3.500	HBR 82/5/4	\$4,915.82	HBR 100/5/5,5	\$5,263.44	HBR 100/7/5,5	\$5,762.12
4.000	HBR 82/5/4	\$5,456.36	HBR 100/5/5,5	\$5,885.88	HBR 130/7/7,5	\$6,122.48
4.500	HBR 82/5/4	\$5,629.26	HBR 100/5/5,5	\$6,641.18	HBR 130/7/7,5	\$6,823.18
5.000	HBR 100/5/5,5	\$6,211.66	HBR 100/5/7,5	\$7,037.94	HBR 130/7/9,2	\$7,214.48
5.500	HBR 100/5/5,5	\$6,686.68	HBR 100/5/7,5	\$7,205.38	HBR 130/7/9,2	\$7,629.44
6.000	HBR 100/5/5,5	\$6,859.58	HBR 100/5/7,5	\$7,371.00	HBR 130/7/9,2	\$7,862.40
6.500	HBR 100/5/5,5	\$7,119.84	HBR 100/5/7,5	\$7,543.90	HBR 130/7/9,2	\$8,275.54
7.000	HBR 100/5/7,5	\$7,400.12	HBR 130/5/9,2	\$8,350.16	HBR 130/7/11	\$8,796.06
7.500	HBR 100/5/7,5	\$7,853.30	HBR 130/5/9,2	\$8,508.50	HBR 130/7/11	\$8,968.96
8.000	HBR 100/5/7,5	\$8,102.64	HBR 130/5/9,2	\$8,668.66	HBR 130/7/11	\$9,241.96
8.500	HBR 100/5/7,5	\$8,264.62	HBR 130/5/9,2	\$8,827.00	HBR 130/7/11	\$9,473.10
9.000	HBR 100/5/7,5	\$8,426.60	HBR 130/5/9,2	\$8,990.80	HBR 130/7/11	\$9,882.60
9.500	HBR 100/5/7,5	\$8,654.10	HBR 130/5/9,2	\$9,150.96	HBR 130/7/11	\$10,272.08
10.000	HBR 100/5/7,5	\$9,194.64	HBR 130/5/11	\$10,144.68	HBR 130/7/15	\$10,535.98
10.500	HBR 100/5/7,5	\$9,323.86	HBR 130/5/11	\$10,528.70	HBR 130/7/15	\$10,949.12
11.000	HBR 100/5/7,5	\$9,549.54	HBR 130/5/11	\$11,189.36	HBR 130/7/15	\$11,429.60
11.500	HBR 100/5/7,5	\$10,339.42	HBR 130/5/11	\$11,353.16	HBR 130/7/15	\$11,775.40
12.000	HBR 130/5/9,2	\$10,619.70	HBR 130/5/11	\$11,511.50	HBR 130/7/15	\$12,301.38
12.500	HBR 130/5/9,2	\$11,160.24	HBR 130/5/11	\$11,671.66	HBR 130/7/15	\$12,532.52
13.000	HBR 130/5/9,2	\$11,786.32	HBR 130/5/15	\$12,758.20	HBR 130/7/15	\$13,074.88
13.500	HBR 130/5/9,2	\$12,068.42	HBR 130/5/15	\$12,918.36	HBR 130/7/15	\$13,335.14
14.000	HBR 130/5/9,2	\$12,315.94	HBR 130/5/15	\$13,076.70	HBR 162/7/18,5	\$14,470.82
14.500	HBR 130/5/9,2	\$12,758.20	HBR 130/5/15	\$13,236.86	HBR 162/7/18,5	\$15,262.52
15.000	HBR 130/5/11	\$13,109.46	HBR 130/5/15	\$13,528.06	HBR 162/7/18,5	\$15,626.52
15.500	HBR 130/5/11	\$13,366.08	HBR 130/5/15	\$13,688.22	HBR 162/7/18,5	\$16,283.54
16.000	HBR 130/5/11	\$13,571.74	HBR 130/5/15	\$14,101.36	HBR 162/7/22	\$16,700.32
16.500	HBR 130/5/11	\$14,050.40	HBR 130/5/15	\$14,867.58	HBR 162/7/22	\$17,189.90
17.000	HBR 130/5/11	\$14,394.38	HBR 162/5/18,5	\$15,937.74	HBR 162/7/22	\$17,501.12
17.500	HBR 130/5/11	\$14,651.00	HBR 162/5/18,5	\$16,090.62	HBR 162/7/22	\$18,074.42
18.000	HBR 130/5/11	\$14,971.32	HBR 162/5/18,5	\$16,248.96	HBR 162/7/22	\$18,678.66
Included:	Universal inlet with flange for 200mm butterfly valve		Universal inlet with flange for 250mm butterfly valve		Universal inlet with flange for 300mm butterfly valve	

NOTE: The given capacities are the nominal values for Portland Cement with 1,13 t/m³ density and normal operating conditions. And it will differ according to material fluidity and feeding method.

SCS SCREW CONVEYORS WITH DRIVE GROUP

Length mm	SCS 323 (110 ton/h)				
	Drive Group	Price			
1.000	HBR162/10/11	\$5,911.36			
1.500	HBR162/10/11	\$6,260.80			
2.000	HBR162/10/11	\$6,522.88			
2.500	HBR162/10/11	\$6,764.94			
3.000	HBR162/10/11	\$6,950.58			
3.500	HBR162/10/11	\$7,396.48			
4.000	HBR 162/10/11	\$8,031.66			
4.500	HBR 162/10/11	\$8,499.40			
5.000	HBR 162/10/11	\$8,901.62			
5.500	HBR 162/10/11	\$9,391.20			
6.000	HBR 162/10/15	\$10,397.66			
6.500	HBR 162/10/15	\$11,151.14			
7.000	HBR 162/10/15	\$11,640.72			
7.500	HBR 162/10/15	\$12,095.72			
8.000	HBR 162/10/18,5	\$13,062.14			
8.500	HBR 162/10/18,5	\$13,580.84			
9.000	HBR 162/10/18,5	\$14,483.56			
9.500	HBR 162/10/18,5	\$15,173.34			
10.000	HBR 162/10/22	\$15,777.58			
10.500	HBR 162/10/22	\$16,764.02			
11.000	HBR 162/10/22	\$17,093.44			
11.500	HBR 162/10/22	\$17,295.46			
12.000	HBR 162/10/22	\$17,528.42			
12.500	HBR 162/10/22	\$17,772.30			
13.000	HBR 162/10/22	\$18,462.08			
13.500	HBR 162/10/22 ***	\$19,894.42			
14.000	HBR 162/10/22 ***	\$20,340.32			
14.500	HBR 162/10/22 ***	\$20,786.22			
15.000					
15.500					
16.000					
16.500					
17.000					
17.500					
18.000					
			WITH DOUBLE DRIVE GROUP AT INLET AND OUTLET SIDE		
			Length mm	Drive Group	Price
			13.500	2 x (HBR162/10/15)***	\$30,004.52
			14.000	2 x (HBR162/10/15)***	\$30,390.36
			14.500	2 x (HBR162/10/15)***	\$30,721.60
			15.000	2 x (HBR162/10/15)***	\$30,974.58
			15.500	2 x (HBR162/10/15)***	\$31,358.60
			16.000	2 x (HBR162/10/15)***	\$32,317.74
			16.500	2 x (HBR162/10/15)***	\$32,758.18
			17.000	2 x (HBR162/10/15)***	\$33,022.08
			17.500	2 x (HBR162/10/15)***	\$33,307.82
			18.000	2 x (HBR162/10/15)***	\$33,682.74
Included:	Universal inlet with flange for 300mm butterfly valve	Included:	Universal inlet with flange for 300mm butterfly valve		

*** Please consult engineering before making proposal.

NOTE: The given capacities are the nominal values for Portland Cement with 1,13 t/m³ density and normal operating conditions. And it will differ according to material fluidity and feeding method.

SCSR	SCREW CONVEYOR FOR CEMENT IN BATCHING PLANTS WITH VARIANTS DEPENDING ON CLIENT'S SPECIFICATION ON DEMAND	
-------------	---	--

Specifications	Standard Configuration	Option
Outer Pipe Diameter:	114, 139, 168, 193, 219, 273, 323 mm	None
Inlet:	Cylindrical inlet without flange	Available
Outlet:	Cylindrical outlet without flange	Available
Additional Inlet & Outlet:	None	Available
Inlet End Bearing:	If drive group at inlet side: Without If drive group at outlet side: SCEB.R	None
Outlet End Bearing:	If drive group at inlet side: SCEB If drive group at outlet side: Without	None
Hanger Bearing:	SCIB	None
Flight:	Standard	None
Shaft:	Standard	None
Drive Group Position:	Inlet side	Outlet side
Inspection Hatch:	Fully cover with EPDM, available as standard under the inlet and hanger bearings.	Available
Gearbox:	HBR	HBRD
Gear Ratio:	114 & 139 & 168 & 193 & 219mm: 1/5 273mm: 1/7 323mm: 1/10	1/5, 1/7, 1/10
Electric Motor:	△230 / Y 400V 50 Hz < 4kW △400 / Y 690V 50 Hz ≥ 4kW Efficiency class: IE3 Protection class: IP 55 Insulation class: F (155 °C)	Different voltage & frequency options are available.
Inclination:	0 - 44°	0 - 44°
Finishing:	Sand blasted and powder coated 80 microns in caterpillar yellow for conveyor housing	Different colour options are available only for conveyor housing
Accessories:	None	Available
Tungsten-carbide coating on flight edges:	None	Available
Reversible:	None	None
Distributing:	None	None
Collecting:	None	None
Injection:	None	None
Without Hanger Bearing:	None	None

SCSR SCREW CONVEYORS WITH DRIVE GROUP

Length mm	SCSR 114 (4 ton/h)		SCSR 139 (5 ton/h)		SCSR 168 (25 ton/h)	
	Drive Group	Price	Drive Group	Price	Drive Group	Price
1.000	HBRD82/5/2,2	\$2,830.10	HBRD82/5/2,2	\$3,194.10	HBR 82/5/3	\$3,445.26
1.500	HBRD82/5/2,2	\$2,837.38	HBRD82/5/2,2	\$3,352.44	HBR 82/5/3	\$3,630.90
2.000	HBRD82/5/2,2	\$2,962.96	HBRD82/5/2,2	\$3,505.32	HBR 82/5/3	\$3,783.78
2.500	HBRD82/5/2,2	\$3,094.00	HBRD82/5/2,2	\$3,658.20	HBR 82/5/3	\$3,876.60
3.000	HBRD82/5/2,2	\$3,223.22	HBRD82/5/2,2	\$3,811.08	HBR 82/5/4	\$4,215.12
3.500	HBRD82/5/2,2	\$3,354.26	HBRD82/5/2,2	\$3,963.96	HBR 82/5/4	\$4,368.00
4.000	HBRD82/5/2,2	\$4,198.74	HBRD82/5/2,2	\$4,326.14	HBR 82/5/4	\$4,919.46
4.500	HBRD82/5/2,2	\$4,347.98	HBRD82/5/2,2	\$4,479.02	HBR 82/5/4	\$5,048.68
5.000	HBRD82/5/2,2	\$4,499.04	HBRD82/5/3	\$4,659.20	HBR 82/5/4	\$5,163.34
5.500	HBRD82/5/2,2	\$4,642.82	HBRD82/5/3	\$4,784.78	HBR 82/5/4	\$5,547.36
6.000	HBRD82/5/2,2	\$4,792.06	HBRD82/5/3	\$4,939.48	HBR 100/5/4	\$5,787.60
6.500	HBRD82/5/2,2	\$4,943.12	HBRD82/5/3	\$5,125.12	HBR 100/5/4	\$5,976.88
7.000	HBRD82/5/2,2	\$5,345.34	HBRD82/5/4	\$6,055.14	HBR 100/5/5,5	\$7,016.10
7.500	HBRD82/5/2,2	\$5,492.76	HBRD82/5/4	\$6,193.46	HBR 100/5/5,5	\$7,148.96
8.000	HBRD82/5/2,2	\$5,643.82	HBRD82/5/4	\$6,353.62	HBR 100/5/5,5	\$7,269.08
8.500	HBRD82/5/2,2	\$5,849.48	HBRD82/5/4	\$6,726.72	HBR 100/5/5,5	\$7,387.38
9.000	HBRD82/5/2,2	\$6,002.36	HBRD82/5/4	\$7,036.12	HBR 100/5/5,5	\$7,527.52
9.500	HBRD82/5/3	\$6,302.66	HBRD82/5/4	\$7,261.80	HBR 100/5/5,5	\$7,720.44
10.000	HBRD82/5/3	\$6,874.14	HBRD82/5/4	\$7,720.44	HBR 100/5/7,5	\$8,024.38
10.500	HBRD82/5/3	\$7,065.24	HBRD82/5/4	\$8,424.78	HBR 100/5/7,5	\$8,554.00
11.000	HBRD82/5/3	\$7,265.44	HBRD82/5/4	\$8,648.64	HBR 100/5/7,5	\$8,941.66
11.500	HBRD82/5/3	\$7,425.60	HBRD82/5/4	\$8,819.72	HBR 100/5/7,5	\$9,163.70
12.000	HBRD82/5/3	\$7,536.62	HBRD82/5/4	\$8,927.10	HBR 100/5/7,5	\$9,340.24
12.500	HBRD82/5/3	\$7,838.74	HBRD82/5/4	\$9,109.10	HBR 100/5/7,5	\$9,622.34
13.000	HBRD82/5/3	\$8,379.28	HBRD82/5/4	\$9,995.44	HBR 100/5/7,5	\$10,124.66
13.500					HBR 100/5/7,5	\$10,293.92
14.000					HBR 100/5/7,5	\$10,472.28
14.500					HBR 100/5/7,5	\$10,980.06
15.000					HBR 100/5/7,5	\$11,314.94
15.500					HBR 100/5/7,5	\$11,544.26
16.000					HBR 130/5/9,2	\$11,824.54
16.500					HBR 130/5/9,2	\$11,986.52
17.000					HBR 130/5/9,2	\$12,090.26
17.500					HBR 130/5/9,2	\$12,357.80
18.000					HBR 130/5/9,2	\$12,537.98
Drive group at outlet		\$273.00		\$273.00		\$327.60

NOTE: The given capacities are the nominal values for Portland Cement with 1,13 t/m³ density and normal operating conditions. And it will differ according to material fluidity and feeding method.

SCSR SCREW CONVEYORS WITH DRIVE GROUP

Length mm	SCSR 193 (40 ton/h)		SCSR 219 (60 ton/h)		SCSR 273 (90 ton/h)	
	Drive Group	Price	Drive Group	Price	Drive Group	Price
1.000	HBR 82/5/4	\$3,831.10	HBR 100/5/5,5	\$4,136.86	HBR 100/7/5,5	\$4,393.48
1.500	HBR 82/5/4	\$3,994.90	HBR 100/5/5,5	\$4,495.40	HBR 100/7/5,5	\$4,673.76
2.000	HBR 82/5/4	\$4,167.80	HBR 100/5/5,5	\$4,657.38	HBR 100/7/5,5	\$4,910.36
2.500	HBR 82/5/4	\$4,375.28	HBR 100/5/5,5	\$4,810.26	HBR 100/7/5,5	\$5,179.72
3.000	HBR 82/5/4	\$4,560.92	HBR 100/5/5,5	\$4,966.78	HBR 100/7/5,5	\$5,414.50
3.500	HBR 82/5/4	\$4,759.30	HBR 100/5/5,5	\$5,121.48	HBR 100/7/5,5	\$5,598.32
4.000	HBR 82/5/4	\$5,310.76	HBR 100/5/5,5	\$5,731.18	HBR 130/7/7,5	\$5,962.32
4.500	HBR 82/5/4	\$5,467.28	HBR 100/5/5,5	\$6,475.56	HBR 130/7/7,5	\$6,663.02
5.000	HBR 100/5/5,5	\$6,042.40	HBR 100/5/7,5	\$6,868.68	HBR 130/7/9,2	\$7,041.58
5.500	HBR 100/5/5,5	\$6,524.70	HBR 100/5/7,5	\$7,032.48	HBR 130/7/9,2	\$7,462.00
6.000	HBR 100/5/5,5	\$6,699.42	HBR 100/5/7,5	\$7,203.56	HBR 130/7/9,2	\$7,700.42
6.500	HBR 100/5/5,5	\$6,956.04	HBR 100/5/7,5	\$7,376.46	HBR 130/7/9,2	\$8,119.02
7.000	HBR 100/5/7,5	\$7,238.14	HBR 130/5/9,2	\$8,175.44	HBR 130/7/11	\$8,637.72
7.500	HBR 100/5/7,5	\$7,694.96	HBR 130/5/9,2	\$8,337.42	HBR 130/7/11	\$8,814.26
8.000	HBR 100/5/7,5	\$7,931.56	HBR 130/5/9,2	\$8,483.02	HBR 130/7/11	\$9,063.60
8.500	HBR 100/5/7,5	\$8,093.54	HBR 130/5/9,2	\$8,646.82	HBR 130/7/11	\$9,292.92
9.000	HBR 100/5/7,5	\$8,255.52	HBR 130/5/9,2	\$8,819.72	HBR 130/7/11	\$9,709.70
9.500	HBR 100/5/7,5	\$8,483.02	HBR 130/5/9,2	\$8,978.06	HBR 130/7/11	\$10,101.00
10.000	HBR 100/5/7,5	\$9,029.02	HBR 130/5/11	\$9,968.14	HBR 130/7/15	\$10,361.26
10.500	HBR 100/5/7,5	\$9,156.42	HBR 130/5/11	\$10,355.80	HBR 130/7/15	\$10,779.86
11.000	HBR 100/5/7,5	\$9,383.92	HBR 130/5/11	\$11,012.82	HBR 130/7/15	\$11,263.98
11.500	HBR 100/5/7,5	\$10,175.62	HBR 130/5/11	\$11,189.36	HBR 130/7/15	\$11,607.96
12.000	HBR 130/5/9,2	\$10,446.80	HBR 130/5/11	\$11,334.96	HBR 130/7/15	\$12,128.48
12.500	HBR 130/5/9,2	\$10,987.34	HBR 130/5/11	\$11,493.30	HBR 130/7/15	\$12,363.26
13.000	HBR 130/5/9,2	\$11,618.88	HBR 130/5/15	\$12,576.20	HBR 130/7/15	\$12,909.26
13.500	HBR 130/5/9,2	\$11,895.52	HBR 130/5/15	\$12,734.54	HBR 130/7/15	\$13,158.60
14.000	HBR 130/5/9,2	\$12,141.22	HBR 130/5/15	\$12,898.34	HBR 162/7/18,5	\$14,296.10
14.500	HBR 130/5/9,2	\$12,578.02	HBR 130/5/15	\$13,062.14	HBR 162/7/18,5	\$15,093.26
15.000	HBR 130/5/11	\$12,923.82	HBR 130/5/15	\$13,349.70	HBR 162/7/18,5	\$15,459.08
15.500	HBR 130/5/11	\$13,176.80	HBR 130/5/15	\$13,509.86	HBR 162/7/18,5	\$16,108.82
16.000	HBR 130/5/11	\$13,378.82	HBR 130/5/15	\$13,917.54	HBR 162/7/22	\$16,521.96
16.500	HBR 130/5/11	\$13,852.02	HBR 130/5/15	\$14,672.84	HBR 162/7/22	\$17,006.08
17.000	HBR 130/5/11	\$14,188.72	HBR 162/5/18,5	\$15,730.26	HBR 162/7/22	\$17,315.48
17.500	HBR 130/5/11	\$14,441.70	HBR 162/5/18,5	\$15,881.32	HBR 162/7/22	\$17,881.50
18.000	HBR 130/5/11	\$14,758.38	HBR 162/5/18,5	\$16,036.02	HBR 162/7/22	\$18,480.28
Drive group at outlet		\$327.60		\$382.20		\$409.50

NOTE: The given capacities are the nominal values for Portland Cement with 1,13 t/m³ density and normal operating conditions. And it will differ according to material fluidity and feeding method.

SCSR SCREW CONVEYORS WITH DRIVE GROUP

Length mm	SCSR 323 (110 ton/h)				
	Drive Group	Price			
1.000	HBR162/10/11	\$5,678.40			
1.500	HBR162/10/11	\$6,026.02			
2.000	HBR162/10/11	\$6,308.12			
2.500	HBR162/10/11	\$6,559.28			
3.000	HBR162/10/11	\$6,752.20			
3.500	HBR162/10/11	\$7,218.12			
4.000	HBR 162/10/11	\$7,866.04			
4.500	HBR 162/10/11	\$8,330.14			
5.000	HBR 162/10/11	\$8,726.90			
5.500	HBR 162/10/11	\$9,191.00			
6.000	HBR 162/10/15	\$10,195.64			
6.500	HBR 162/10/15	\$10,960.04			
7.000	HBR 162/10/15	\$11,451.44			
7.500	HBR 162/10/15	\$11,906.44			
8.000	HBR 162/10/18,5	\$12,880.14			
8.500	HBR 162/10/18,5	\$13,395.20			
9.000	HBR 162/10/18,5	\$14,292.46			
9.500	HBR 162/10/18,5	\$14,985.88			
10.000	HBR 162/10/22	\$15,591.94			
10.500	HBR 162/10/22	\$16,589.30			
11.000	HBR 162/10/22	\$16,918.72			
11.500	HBR 162/10/22	\$17,117.10			
12.000	HBR 162/10/22	\$17,350.06			
12.500	HBR 162/10/22	\$17,595.76			
13.000	HBR 162/10/22	\$18,287.36			
			WITH DOUBLE DRIVE GROUP (AT INLET AND OUTLET SIDE)		
			Length mm	Drive Group	Price
			13.500	2 x (HBR162/10/15)***	\$30,535.96
			14.000	2 x (HBR162/10/15)***	\$30,932.72
			14.500	2 x (HBR162/10/15)***	\$31,276.70
			15.000	2 x (HBR162/10/15)***	\$31,536.96
			15.500	2 x (HBR162/10/15)***	\$31,935.54
			16.000	2 x (HBR162/10/15)***	\$32,923.80
			16.500	2 x (HBR162/10/15)***	\$33,380.62
			17.000	2 x (HBR162/10/15)***	\$33,651.80
			17.500	2 x (HBR162/10/15)***	\$33,948.46
			18.000	2 x (HBR162/10/15)***	\$34,334.30
Drive group at outlet		\$445.90			

*** Please consult engineering before making proposal.

NOTE: The given capacities are the nominal values for Portland Cement with 1,13 t/m³ density and normal operating conditions. And it will differ according to material fluidity and feeding method.

UNIVERSAL INLET & OUTLET WITH FLANGE FOR BUTTERFLY VALVES					
Code	Ø D	Flange	Price	Additional	For
U.168.BV.200	168	BV.200	\$293.02	\$336.70	SCSR SCR SCP SCE SCH
U.193.BV.200	193	BV.200	\$300.30	\$345.80	
U.219.BV.250	219	BV.250	\$340.34	\$391.30	
U.273.BV.300	273	BV.300	\$393.12	\$451.36	
U.323.BV.300	323	BV.300	\$447.72	\$515.06	

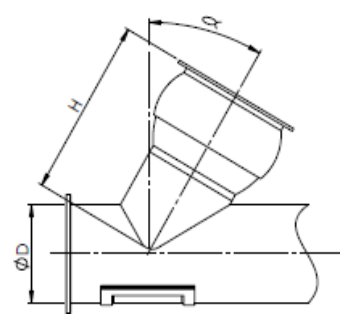

UNIVERSAL INLET & OUTLET WITH FLANGE FOR SLIDE VALVES					
Code	Ø D	Flange	Price	Additional	For
U.168.SV.200	168	SVC.200	\$347.62	\$398.58	SCSR SCR SCP SCE SCH
U.193.SV.200	193	SVC.200	\$356.72	\$411.32	
U.219.SV.250	219	SVC.250	\$404.04	\$465.92	
U.273.SV.300	273	SVC.300	\$465.92	\$535.08	
U.323.SV.300	323	SVC.300	\$531.44	\$609.70	



ADDITIONAL CYLINDRICAL INLET & OUTLET WITHOUT FLANGE				
Code	Ø D	Ø A	Additional	For
C.114.114	114	114	\$203.84	SCSR SCR SCP SCE SCH SCU SCUV
C.139.139	139	139	\$247.52	
C.168.168	168	168	\$247.52	
C.193.193	193	193	\$336.70	
C.219.219	219	219	\$458.64	
C.273.273	273	273	\$509.60	
C.323.323	323	323	\$571.48	
C.406.406	406	406	\$677.04	

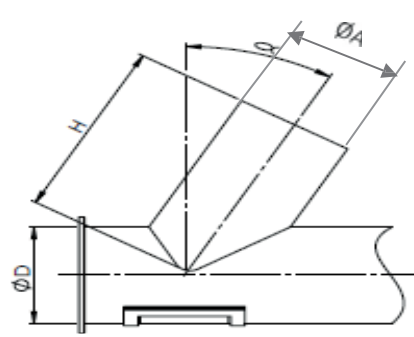

SCS OPTIONS FOR INLET AND OUTLET

EXTRA PRICE FOR BEADED CYLINDRICAL INLET & OUTLET			
Code	Ø D	Price	For
K.114.114	114	\$74.62	SCSR SCR SCP SCE SCH SCU SCUV
K.139.139	139	\$80.08	
K.168.168	168	\$100.10	
K.193.193	193	\$109.20	
K.219.219	219	\$123.76	
K.273.273	273	\$136.50	
K.323.323	323	\$149.24	
K.406.406	406	\$169.26	

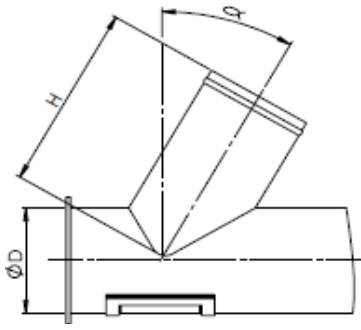

FLANGE FOR BUTTERFLY VALVES				
Code	Ø Valve	Price	Additional	For
SC.F.BV.100	BV.100	\$76.44	\$87.36	SCSR SCR SCP SCE SCV SCH SCU SCUV
SC.F.BV.150	BV.150	\$118.30	\$136.50	
SC.F.BV.200	BV.200	\$123.76	\$141.96	
SC.F.BV.250	BV.250	\$140.14	\$161.98	
SC.F.BV.300	BV.300	\$176.54	\$203.84	
SC.F.BV.350	BV.350	\$218.40	\$251.16	
SC.F.BV.400	BV.400	\$282.10	\$323.96	

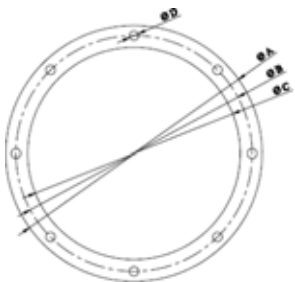

FLANGE FOR SLIDE VALVES				
Code	Ø Valve	Price	Additional	For
SC.F.SVC.150	(SVC) 150	\$152.88	\$176.54	SCSR SCR SCP SCE SCV SCH SCU SCUV
SC.F.SVC.200	(SVC) 200	\$160.16	\$183.82	
SC.F.SVC.250	(SVC) 250	\$187.46	\$214.76	
SC.F.SVC.300	(SVC) 300	\$200.20	\$231.14	
SC.F.SVC.350	(SVC) 350	\$209.30	\$240.24	
SC.F.SVC.400	(SVC) 400	\$218.40	\$251.16	

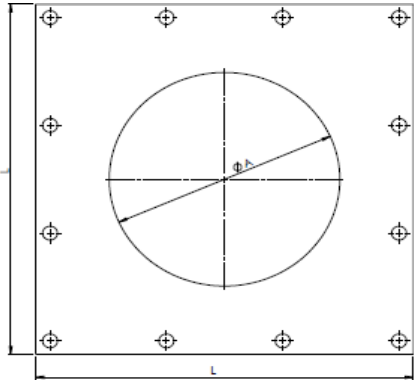

SQUARE INLET & OUTLET WITH FLANGE FOR SLIDE VALVES					
Code	Ø D	Flange	Price	Additional	For
Q.168.150	168	SVQ150	\$422.24	\$485.94	SCSR SCR SCP SCE SCH SCU SCUV
Q.193.200	193	SVQ200	\$480.48	\$553.28	
Q.219.250	219	SVQ250	\$493.22	\$567.84	
Q.273.300	273	SVQ300	\$538.72	\$618.80	
Q.323.350	323	SVQ350	\$633.36	\$729.82	
Q.406.400	406	SVQ400	\$680.68	\$782.60	

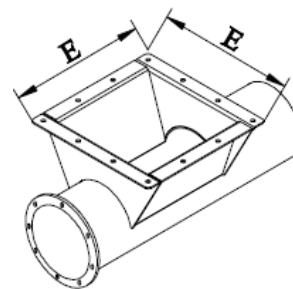

RECTANGULAR INLET & OUTLET WITH FLANGE FOR SLIDE VALVES					
Code	Ø D	Flange	Price	Additional	For
R.168.200	168	SVR200	\$524.16	\$602.42	SCSR SCR SCP SCE SCH SCU SCUV
R.193.200	193	SVR200	\$549.64	\$633.36	
R.219.200	219	SVR200	\$602.42	\$693.42	
R.273.300	273	SVR300	\$667.94	\$768.04	
R.323.300	323	SVR300	\$695.24	\$798.98	
R.323.300	323	SVR300	\$728.00	\$837.20	

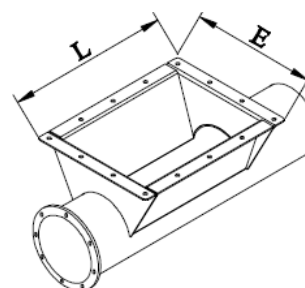

HOPPER FOR BAG SPLITTING WITH CUTTING BLADE				
Code	Ø D	Price	Volume	For
SC.I.H168.X	168	\$1,183.00	Nominal 300-350 lt	SCSR SCR SCP SCE
SC.I.H193.X	193			
SC.I.H219.X	219			
SC.I.H273.X	273			
SC.I.H323.X	323			

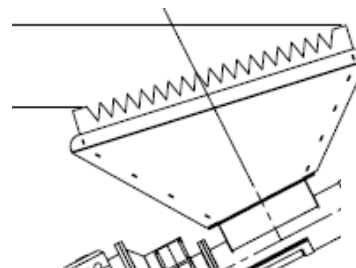

DEFLECTOR FOR OUTLET					
Code	Ø D mm	Ø A mm	Ø B mm	Price	For
SCV-D.168	168	230	168	\$63.70	SCSR SCR SCP SCE SCV SCH
SCV-D.193	193	275	193	\$72.80	
SCV-D.219	219	330	219	\$100.10	
SCV-D.273	273	330	273	\$118.30	
SCV-D.323	323	380	323	\$154.70	

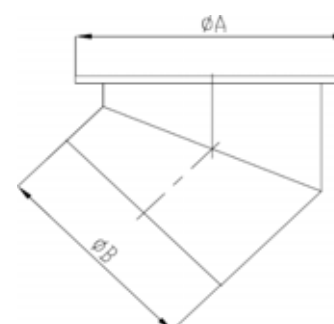

SCS OPTIONS FOR INLET AND OUTLET

CONICAL ADAPTOR WITH ROUND FLANGES				
Code	ØB - ØA	H mm	Price	For
SCS07007000	C100 - C150		\$125.58	SCS SCSR SCR SCP SCE SCV SCH SCU SCUV
SCS07007010	C150 - C200	95	\$136.50	
SCS07007020	C200 - C250	105	\$154.70	
SCS07007030	C200 - C300	110	\$182.00	
SCS07007040	C250 - C300	110	\$209.30	
SCS07007050	C300 - C350	110	\$254.80	
	C300 - C400		\$336.70	
	C350 - C400		\$354.90	

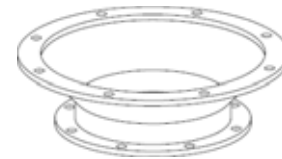
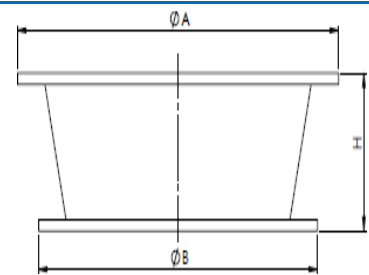

CONICAL ADAPTOR WITH SQUARE FLANGES				
Code	ØB - ØA	H mm	Price	For
	Q150 - Q200		\$156.52	SCS SCSR SCR SCP SCE SCV SCH SCU SCUV
SCS07007120	Q150 - Q250		\$178.36	
	Q200 - Q250		\$209.30	
SCS07007130-2	Q200 - Q300		\$240.24	
SCS07007140	Q250 - Q300		\$293.02	
SCS07007150	Q300 - Q350		\$387.66	
	Q350 - Q400		\$407.68	

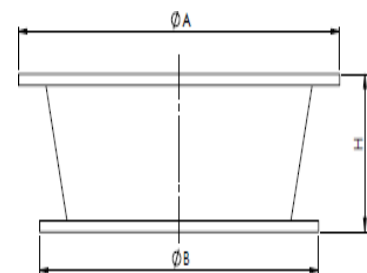

HBR TYPE GEARBOXES SCSS SEAL IS INCLUDED					
Type	Gear Ratio	Electric Motor		Price	For
		Power	Size		
HBR 82	1/5, 1/7, 1/10	2,2 - 3 kW	100	\$1,379.56	SCSR SCR SCH
		4 kW	112	\$1,412.32	
HBR 100	1/5, 1/7, 1/10	4 kW	112	\$1,827.28	
		5,5 - 7,5 - 9 kW	132	\$1,858.22	
HBR 130	1/5, 1/7, 1/10	5,5 - 7,5 - 9 kW	132	\$2,262.26	
		11 - 15 kW	160	\$2,355.08	
HBR 162	1/5, 1/7, 1/10	11 - 15 kW	160	\$3,483.48	
		18,5 - 22 kW	180	\$3,614.52	



HBRD TYPE GEARBOXES					
Type	Gear Ratio	Electric Motor		Price	For
		Power	Size		
HBRD 82	1/5, 1/7, 1/10	2,2 - 3 kW	100	\$1,437.80	SCSR SCR SCH
		4 kW	112	\$1,494.22	
HBRD 100	1/5, 1/7, 1/10	4 kW	112	\$1,889.16	
		5,5 - 7,5 - 9 kW	132	\$2,071.16	
HBRD 130	1/5, 1/7, 1/10	5,5 - 7,5 - 9 kW	132	\$2,325.96	
		11 - 15 kW	160	\$2,458.82	
HBRD 162	1/5, 1/7, 1/10	11 - 15 kW	160	\$3,636.36	
		18,5 - 22 kW	180	\$3,918.46	



SCS OPTIONS FOR DRIVE GROUP

ELECTRIC MOTORS			
Power kW	Size	Price	380V-60Hz Extra Price
0,75	80	\$959.45	\$105.29
1,1	90	\$1,146.00	\$128.33
1,5	90	\$1,371.06	\$151.35
2,2	100	\$1,729.36	\$180.96
3	100	\$1,898.15	\$210.57
4	112	\$2,336.41	\$259.93
5,5	132	\$2,887.21	\$322.45
7,5	132	\$3,374.86	\$378.38
9	132	\$3,957.95	\$440.90
11	160	\$5,377.39	\$602.11
15	160	\$6,490.58	\$723.85
18,5	180	\$7,494.78	\$839.02
22	180	\$9,199.88	\$1,026.55

Voltage & Frequency:
 Δ230 / Y 400V 50 Hz < 4kW
 Δ400 / Y 690V 50 Hz ≥ 4kW

Efficiency class: IE3
Protection class: IP 55
Insulation class: F (155 °C)
Flange: B5



PLEASE SPECIFY IF DIFFERENT TRADEMARK AND VOLTAGE-FREQUENCY REQUIRED.

EXTRA PRICE FOR DIFFERENT PROTECTION CLASS		
IP 56	7%	In addition to Motor price.
IP 65	9%	
IP 66	10%	
Forced Ventilation	15%	

ADDITIONAL INSPECTION HATCH FOR TUBULAR SCREW CONVEYORS

ØD mm	Code	Description	Price	Material	For	
114		SCIH.E.114 Inspection Hatch	\$227.50	Fully covered with EPDM	SCSR SCR SCP SCE SCV SCH	
		Inspection Hatch Assembly Set	\$1.82			
139		SCIH.E.139 Inspection Hatch	\$240.24			
		Inspection Hatch Assembly Set	\$1.82			
168	SCS06040031	SCIH.E.168 Inspection Hatch	\$282.10			
	SCS06070650	Inspection Hatch Assembly Set	\$1.82			
193	SCS06040041	SCIH.E.193 Inspection Hatch	\$287.56			
	SCS06070650	Inspection Hatch Assembly Set	\$1.82			
219	SCS06040051	SCIH.E.219 Inspection Hatch	\$313.04			
	SCS06070650	Inspection Hatch Assembly Set	\$1.82			
273	SCS06040061	SCIH.E.273 Inspection Hatch	\$320.32			
	SCS06070650	Inspection Hatch Assembly Set	\$1.82			
323	SCS06040071	SCIH.E.323 Inspection Hatch	\$349.44			
	SCS06070650	Inspection Hatch Assembly Set	\$1.82			
406		SCIH.406 Inspection Hatch	\$413.14	Metal		
		Inspection Hatch Assembly Set	\$1.82			
114		SCIH.S.114 Inspection Hatch	\$394.94	Fully covered with Silicone	SCR SCP SCE SCV SCH	
		Inspection Hatch Assembly Set	\$1.82			
139		SCIH.S.139 Inspection Hatch	\$433.16			
		Inspection Hatch Assembly Set	\$1.82			
168		SCIH.S.168 Inspection Hatch	\$493.22			
		Inspection Hatch Assembly Set	\$1.82			
193		SCIH.S.193 Inspection Hatch	\$516.88			
		Inspection Hatch Assembly Set	\$1.82			
219		SCIH.S.219 Inspection Hatch	\$547.82			
		Inspection Hatch Assembly Set	\$1.82			
273		SCIH.S.273 Inspection Hatch	\$575.12			
		Inspection Hatch Assembly Set	\$1.82			
323		SCIH.S.323 Inspection Hatch	\$611.52			
		Inspection Hatch Assembly Set	\$1.82			

EXTRA PRICE FOR INCLINATION	
Inclination	Price
0° - 8°	\$136.50
10° - 20°	\$65.52
22° - 28°	\$0.00
30°	\$0.00
32° - 38°	\$65.52
40° - 44°	\$65.52

COLOUR OPTIONS FOR CONVEYOR HOUSING (EXCEPT SCS)		
Colour	Price €/m	
Caterpillar Yellow	\$0.00	Max admissible temperatures: * Continious: 80°C * Intermittent: 100°C
RAL 1013	\$56.42	
RAL 1015	\$61.88	
RAL 3020	\$69.16	
RAL 5010	\$30.94	
RAL 7035	\$38.22	
RAL 7037	\$78.26	
RAL 7043	\$81.90	
RAL 9002	\$32.76	
RAL 9010	\$41.86	
Other colours	Ask for price	
Galvanize for only outer pipe	18%	In addition to basic unit, without drive group price.
Galvanize for only outer pipe & shaft & flight..	26%	In addition to basic unit, without drive group price.
For high temperature YAŞ BOYA COLOUR Grey	18%	Max admissible temperatures: * Continious: 120°C * Intermittent: 140°C

NOTE: Colour options for drive group and end bearing does not exist.

SCIB	HANGER BEARINGS		
ØD mm	Code	Description	Price
114	SCS04100000	SCIB.114.28 Hanger Bearing	\$236.60
	SCS06070810	Hanger Bearing Assembly Set	\$1.82
139	SCS04200000	SCIB.139.28 Hanger Bearing	\$254.80
	SCS06070810	Hanger Bearing Assembly Set	\$1.82
168	SCS04300000	SCIB.168.40 Hanger Bearing	\$254.80
	SCS06070580	Hanger Bearing Assembly Set	\$1.82
193	SCS04400000	SCIB.193.40 Hanger Bearing	\$263.90
	SCS06070580	Hanger Bearing Assembly Set	\$1.82
219	SCS04500000	SCIB.219.40 Hanger Bearing	\$267.54
	SCS06070580	Hanger Bearing Assembly Set	\$1.82
273	SCS04600000	SCIB.273.40 Hanger Bearing	\$269.36
	SCS06070580	Hanger Bearing Assembly Set	\$1.82
323	SCS04700000	SCIB.323.40 Hanger Bearing	\$280.28
	SCS06070580	Hanger Bearing Assembly Set	\$1.82



COUPLING		
Code	Description	Price
SCS06020010	40x36 Rşaft:60	\$78.26
SCS06020020	40X36 Rşaft:90	\$89.18



SCEB	STANDARD TYPE END BEARINGS		
ØD mm	Code	Description	Price
114	SCS05100001	SCEB.114 End Bearing	\$327.60
		End Bearing Assembly Set	\$1.82
139	SCS05200001	SCEB.139 End Bearing	\$327.60
		End Bearing Assembly Set	\$1.82
168	SCS05300001	SCEB.168 End Bearing	\$360.36
	SCS06070590	End Bearing Assembly Set	\$1.82
193	SCS05400001	SCEB.193 End Bearing	\$378.56
	SCS06070630	End Bearing Assembly Set	\$1.82
219	SCS05500001	SCEB.219 End Bearing	\$404.04
	SCS06070660	End Bearing Assembly Set	\$1.82
273	SCS05600001	SCEB.273 End Bearing	\$431.34
	SCS06070690	End Bearing Assembly Set	\$1.82
323	SCS05700001	SCEB.323 End Bearing	\$562.38
	SCS06070730	End Bearing Assembly Set	\$1.82



HBR TYPE GEARBOXES SCSS SEAL IS NOT INCLUDED					
Type	Gear Ratio	Electric Motor		Price	For
		Power	Size		
HBR 82	1/5, 1/7, 1/10	2,2 - 3 kW	100	\$1,517.88	SCSR SCH SCR
		4 kW	112	\$1,554.28	
HBR 100	1/5, 1/7, 1/10	4 kW	112	\$2,011.10	
		5,5 - 7,5 - 9 kW	132	\$2,043.86	
HBR 130	1/5, 1/7, 1/10	5,5 - 7,5 - 9 kW	132	\$2,489.76	
		11 - 15 kW	160	\$2,589.86	
HBR 162	1/5, 1/7, 1/10	11 - 15 kW	160	\$3,831.10	
		18,5 - 22 kW	180	\$3,976.70	



SEAL				
Code		Suitable Gearbox	Price	For
SCS03010000	SCSS50S	HBR 82, HBR 100, HBR 130	\$127.40	HBR
SCS03030000	SCSS70S	HBR 162	\$191.10	



ELECTRIC MOTORS			
Power kW	Size	Price	380V-60Hz Extra Price
0,75	80	\$589.68	\$58.24
1,1	90	\$704.34	\$70.98
1,5	90	\$842.66	\$83.72
2,2	100	\$997.36	\$100.10
3	100	\$1,166.62	\$116.48
4	112	\$1,435.98	\$143.78
5,5	132	\$1,774.50	\$178.36
7,5	132	\$2,085.72	\$209.30
9	132	\$2,446.08	\$243.88
11	160	\$3,323.32	\$333.06
15	160	\$4,011.28	\$400.40
18,5	180	\$4,631.90	\$464.10
22	180	\$5,685.68	\$567.84

Voltage & Frequency:
 Δ230 / Y 400V 50 Hz < 4kW
 Δ400 / Y 690V 50 Hz ≥ 4kW
Efficiency class: IE3
Protection class: IP 55
Insulation class: F (155 °C)
Flange: B5

PLEASE SPECIFY IF DIFFERENT TRADEMARK AND VOLTAGE-FREQUENCY REQUIRED.



AIRFILL CODE KEY



1	3	4	5	6	7
AIRFILL	25	C	S	08	1,5

1	Unit Code
---	-----------

AIRFILL	
---------	--

3	Filtering Surface
---	-------------------

XX	XX m ²
----	-------------------

4	Filter Element Type
---	---------------------

C	Cartridge
B	Round Bag
E	Elliptical Bag

5	Filter Type
---	-------------

S	Standard
N	Vacuum
R	Filter Element Removable From Inspection Hatch
I	Insertable

5	Filter Body Diameter
---	----------------------

04	400 mm
06	600 mm
08	800 mm
10	1000 mm

6	Fan Motor Power
---	-----------------

0	Without fan
0,75	0,75 kW
1,1	1,1kW
1,5	1,5 kW
2,2	2,2 kW

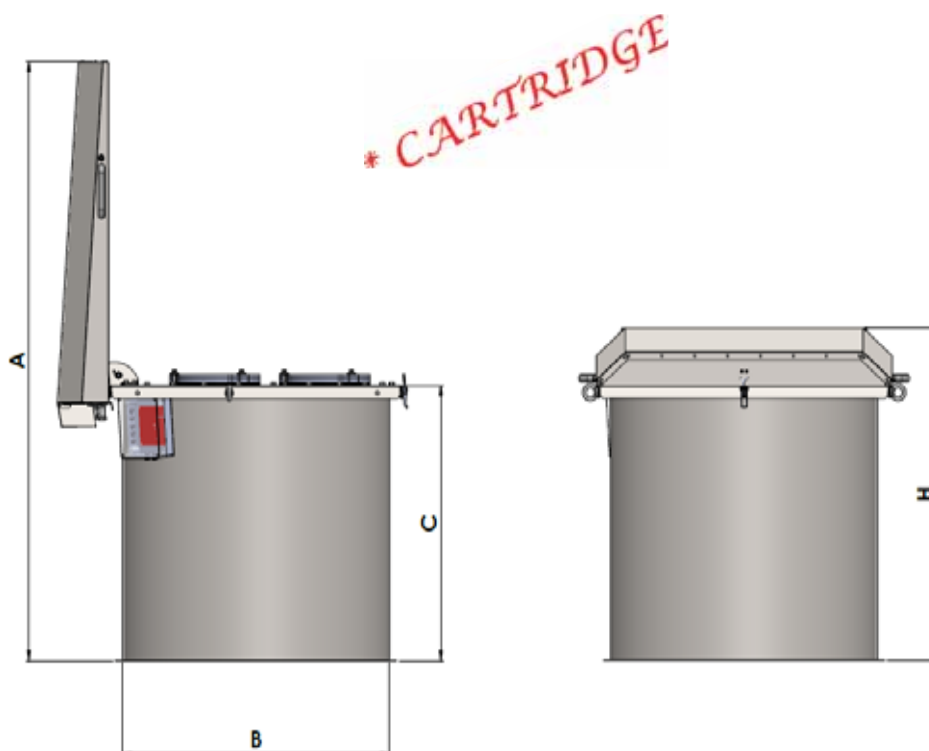

Code	Filtering Area	Filter Element	Price	A mm	ØB mm	C mm	H mm	
AIRFILL D18 AIRFILL Dust-Pro 18	18 m ²	3 pcs FESK218ST	\$3,778.32	1.545	800	700	843	<ul style="list-style-type: none"> * Body: Stainless steel * Cover: Stainless steel * Cleaning system: Jet pulse * Electronic card: included * Connection flange: Fe included * Filter element: Cartridge * Filter element plate: Stainless steel * Inspection hatch: Excluded

PRICE DIFFERENCE FOR STAINLESS STEEL FLANGE		
Code	Price	Material
FRSJ71210013X	\$422.24	AISI 430



AIRFILL FILTERS

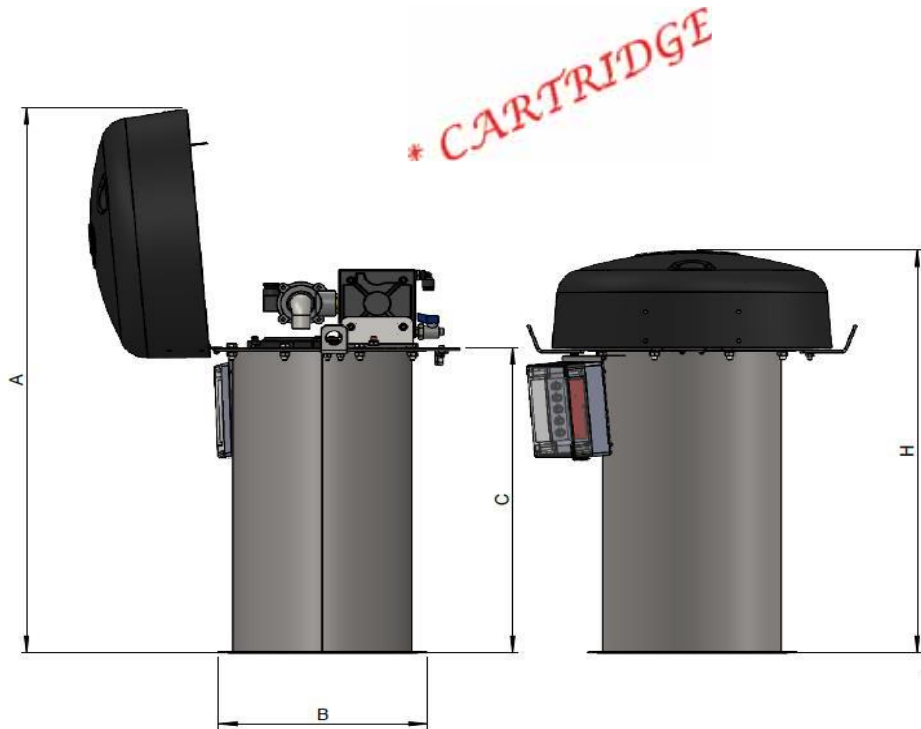

Code	Filtering Area	Filter Element	Price	A mm	ØB mm	C mm	H mm	
AIRFILL 06.C.S.04.0	6 m ²	1 pc FESK218ST	\$2,375.10	1.284	400	698	949	<ul style="list-style-type: none"> * Body: Stainless steel * Cover: Thermoplastic * Cleaning system: Jet pulse * Electronic card: included * Connection flange: Fe included * Filter element: Cartridge * Inspection hatch: Excluded
AIRFILL 09.C.S.04.0	9 m ²	1 pc FELK218ST	\$2,879.24	1.600	400	1.014	1.264	



PRICE DIFFERENCE FOR STAINLESS STEEL FLANGE		
Code	Price	Material
FRSJ51210013X	\$291.20	AISI 430



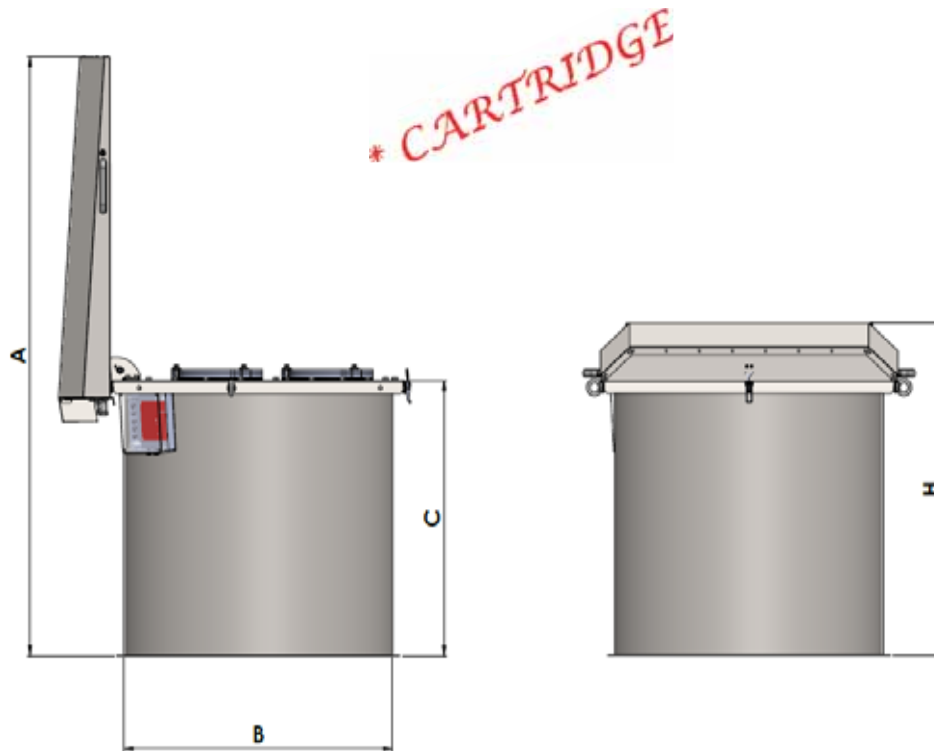

Code	Filtering Area	Filter Element	Price	A mm	ØB mm	C mm	H mm	
AIRFILL 12.C.S.06.0	12 m ²	2 pcs FESK218ST	\$3,392.48	1.371	600	700	880	* Body: Stainless steel * Cover: Stainless steel * Cleaning system: Jet pulse * Electronic card: Included * Connection flange: Fe included * Filter element: Cartridge * Inspection hatch: Excluded
AIRFILL 18.C.S.06.0	18 m ²	2 pcs FELK218ST	\$4,065.88	1.688	600	1.015	1.196	
AIRFILL 25.C.S.08.0	25 m ²	4 pcs FESK218ST	\$4,540.90	1.565	800	700	844	
AIRFILL 36.C.S.08.0	36 m ²	4 pcs FELK218ST	\$6,297.20	1.862	800	1.015	1.160	

PRICE DIFFERENCE FOR STAINLESS STEEL FLANGE			
Code	Price	Diameter	Material
FRSJ61210013X	\$360.36	600	AISI 430
FRSJ71210013X	\$422.24	800	



HOPPERFILL FILTER

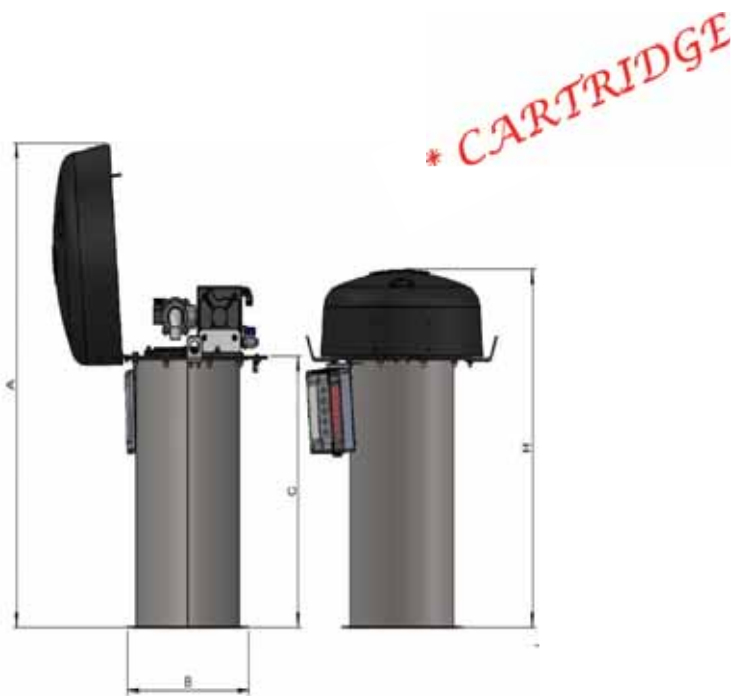

Code	Filtering Area	Filter Element	Price	A mm	ØB mm	C mm	H mm	
HOPPERFILL 01	1 m ²	1 pc FESK115ST	\$1,179.36	934	273	523	690	<ul style="list-style-type: none"> * Body: Stainless steel * Cover: Thermoplastic * Cleaning system: Jet pulse * Electronic card: Included * Connection flange: Fe included * Filter element: Cartridge * Inspection hatch: Excluded

PRICE DIFFERENCE FOR STAINLESS STEEL FLANGE			
Code	Price	Material	
FRSJ91000050X	\$249.34	AISI 430	

PRICES FOR FAN ON FILTER				
Code	Fan Motor Power	For	Price Difference For Fan Preparation	Fan Price
FRSJ00011000	0,75 kW	6 m ² - 36m ²	\$309.40	\$2,249.52
FRSJ00012000	1,1 kW	6 m ² - 36m ²	\$384.02	\$2,366.00
FRSJ00013000	1,5 kW	12m ² - 36m ²	\$496.86	\$2,948.40
FRSJ00014000	2,2 kW	25m ² - 36m ²	\$553.28	\$3,791.06

* Voltage & Frequency: 230/400 V 50 Hz
* Efficiency class: IE3

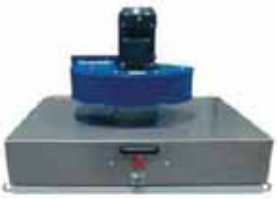

PRICES FOR FAN SIDE ASSEMBLY ON SEPERATE FRAME				
Code	Fan Motor Power	For	Price Difference For Fan Preparation	Fan Price
FRSJ00012000X	2,2 kW	25m ² - 36m ²	\$589.68	\$4,093.18
FRSJ0001500	3 kW	25m ² - 36m ²	\$646.10	\$5,005.00

* Voltage & Frequency: 230/400 V 50 Hz
* Efficiency class: IE3
* Fan + hose + clamp + connector: included



PRICE DIFFERENCE FOR AISI 304 STAINLESS STEEL PLATE		
Code	Price	Filter Diameter
	\$429.52	273
	\$505.96	400
	\$717.08	600
	\$1,002.82	800
	\$1,290.38	1000

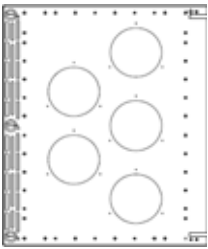

PRICE DIFFERENCE FOR VALVE HEATING SYSTEM		
Filter Diameter	Price	
400	+ \$276.64	Heating system option is not available for HOPPERFILL and AIRFILLV filters.
600	+ \$334.88	
800	+ \$373.10	
1000	+ \$478.66	

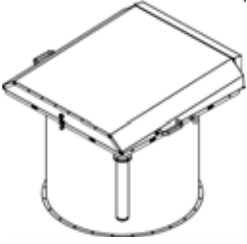

EXHAUST PIPE AND CONNECTION PART

Filter Diameter	Price	
273	\$165.62	
400	\$222.04	
600	\$245.70	
800	\$278.46	
1000	\$318.50	

*** CARTRIDGE
* VIBRATING**

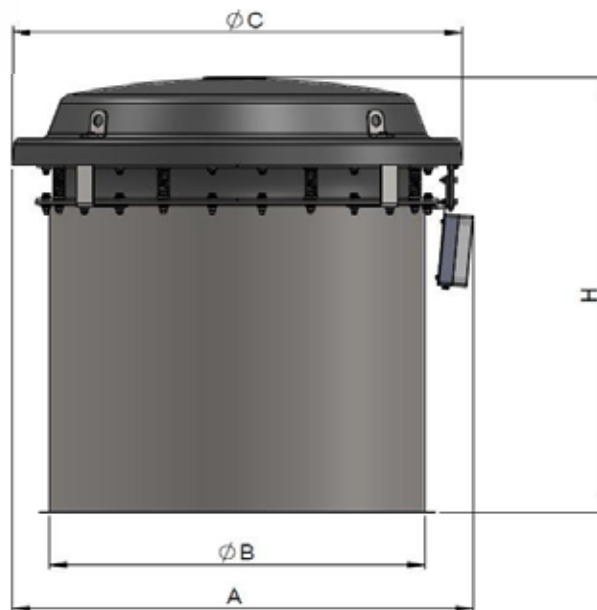

Code	Filtering Area	Filter Element	Price	A mm	ØB mm	ØC mm	H mm	
AIRFILL V18	18 m ²	3 pc FESK218ST Cartridge	\$4,772.04	970	800	945	1.000	<ul style="list-style-type: none"> * Body: Stainless steel * Cover: Thermoplastic * Cleaning system: Vibration * Electronic card: Included * Connection flange: Fe included * Filter element: Cartridge * Inspection hatch: excluded * Vibrator: EVM-M 130/3
AIRFILL V25	25 m ²	4 pc FESK218ST Cartridge	\$5,243.42	970	800	945	1.000	

PRICE DIFFERENCE FOR STAINLESS STEEL FLANGE			
Code	Price	Material	
FRSJ71210013X	\$422.24	AISI 430	

POLYFIL 90 FILTER

*** CARTRIDGE**



Code	Filtering Area	Filter Element	Price	L mm	W mm	H mm	Specifications
POLYFILL 90	90 m ²	10 pcs FELK218ST Cartridge	\$13,690.04	1410	1080	1350	<ul style="list-style-type: none"> * Body: Galvanized * Cover: Galvanized * Columns for body: Galvanized * Cleaning system: Jet pulse * Fan: Excluded * Electronic card: Included * Connection Flange: Excluded
POLYFILLX 90	90 m ²	10 pcs FELK218ST Cartridge	\$18,755.10	1410	1080	1350	<ul style="list-style-type: none"> * Body: Stainless steel * Cover: Stainless steel * Columns for body: Stainless steel * Cleaning system: Jet pulse * Fan: Excluded * Electronic card: Included * Connection Flange: Excluded

FLANGE		
Code	Material	Price
	Fe	\$733.46
	AISI	\$1,792.70

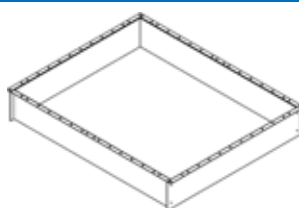

PRICES FOR FAN SIDE ASSEMBLY ON SEPARATE FRAME		
Code	Price	Power
FRSJ00012000-X	\$4,093.18	2,2 kW
FRSJ0001500S	\$5,005.00	3 kW
FRSJ00016000	\$5,915.00	4 kW
FRSJ0001700S	\$8,643.18	5,5 kW
FRSJ0001800S	\$10,008.18	7,5 kW
FRSJ00021000-OM	\$14,838.46	11 kW

Δ230 / Y 400V 50 Hz < 4kW
 Δ400 / Y 690V 50 Hz ≥ 4kW
 Efficiency class: IE3





HOPPER					
Code	Price		Code	Price	
	\$2,771.86	* Material: Galvanized * Outlet: with flange for 250mm butterfly valve * Volume: Nominal 380 lt		\$3,823.82	* Material: Stainless steel * Outlet: with flange for 250mm butterfly valve * Volume: Nominal 380 lt



BIN FOR DUST COLLECTION			
	Price		Price
* Material: Galvanized * Volume: Nominal 44 lt * Valve and flexible bellow: Excluded	\$1,203.02	* Material: Stainless steel * Volume: Nominal 44 lt * Valve and flexible bellow: Excluded	\$1,625.26

FLANGE			
Code	Price	Material	Diameter
FRSJ91000050	\$111.02	Fe	273
FRSJ91000050X	\$387.66	AISI 430	
FRSJ51210013	\$129.22	Fe	400
FRSJ51210013X	\$453.18	AISI 430	
FRSJ61210013	\$160.16	Fe	600
FRSJ61210013X	\$560.56	AISI 430	
FRSJ71210013	\$187.46	Fe	800
FRSJ71210013X	\$657.02	AISI 430	
FRSJ82310070	\$247.52	Fe	1000
FRSJ82310070X	\$866.32	AISI 430	



VALVE AND COIL			
Code	Price	Item No	Description
FRSJ71224000	\$141.96	1	Valve Cover
FRSJ71222010	\$54.60	2	Diapghram
FRSJ71223000	\$25.48	3	Pilot M20x1
N09-0852117	\$7.28	4	Spring
N10-0156018	\$5.46	5	Oring
FRSJ71222040	\$34.58	6	Coil and Socket 24VAC-DC
FRSJ71222000	\$218.40	1 + 2 + 3 + 4 + 5 + 6	1 Complete Set

It is not suitable for HOPPERFILL and AIRFILL V type filters.

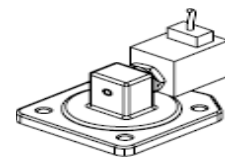
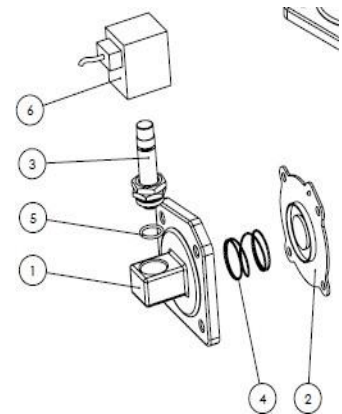

FILTER ELEMENTS					
Code	Suitable Filter	Diameter	H mm	Price	
FE.C.S.115.0500.ST (FESK115ST) Cartridge	HOPPERFILL 01	Ø115	500	\$218.40	
FE.C.S.218.0700.ST (FESK218ST) Cartridge	AIRFILL 06.C.S.04.0 AIRFILL 12.C.S.06.0 AIRFILL 25.C.S.08.0 AIRFILL D18 AIRFILL V18 AIRFILL V25	Ø218	700	\$182.00	
FE.C.S.218.1000.ST (FELK218ST) Cartridge	AIRFILL 09.C.S.04.0 AIRFILL 18.C.S.06.0 AIRFILL 36.C.S.08.0	Ø218	1.000	\$345.80	

FH HOPPER CODE KEY

1	2	3	4
FH	R	1	08

1	Unit Code
---	-----------

FH	Filter Hopper
----	---------------

2	Material
---	----------

1	Fe
X	Stainless Steel

2	Suitable Filter Type
---	----------------------

R	AIRFILL Round Body Filters
P	FP Polygonal Filters

3	Filter Body / Diameter
---	------------------------

04	AIRFILL Ø 400mm
06	AIRFILL Ø 600mm
08	AIRFILL Ø 800mm
10	AIRFILL Ø 1000mm
01	FP 1 body
02	FP 2 body

Code	Filter Diameter	Price		
FHR104	400	\$3,203.20	<p>* Material: St37 + galvanized * Outlet: with flange for BV.250 butterfly valve * Volume: Nominal 550 It for Ø400, Ø600 and Ø800 Nominal 980 It For Ø1000.</p>	
FHR106	600	\$3,272.3		
FHR108	800	\$3,390.66		
FHR110	1000	\$5,030.48		

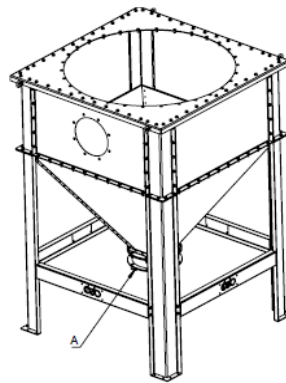
Code	Filter Diameter	Price		
FHRX04	400	\$4,404.40	<p>* Material: AISI430 for body, legs St37+ galvanized * Outlet: with flange for BV.250 butterfly valve * Volume: Nominal 550 It for Ø400, Ø600 and Ø800 Nominal 980 It for Ø1000.</p>	
FHRX06	600	\$4,537.26		
FHRX08	800	\$4,702.88		
FHRX10	1000	\$6,828.64		



BIN FOR DUST COLLECTION

	Price		Price
<p>* Material: Galvanized * Volume: Nominal 44 It * Valve and flexible bellow: Excluded</p>	\$1,203.02	<p>* Material: Stainless steel * Volume: Nominal 44 It * Valve and flexible bellow: Excluded</p>	\$1,625.26

PV PRESSURE RELIEF VALVE



1	2	3	4
PV	273	F	PS

1	Unit Code
---	-----------

PV	Pressure Relief Valve
----	-----------------------

2	Body Diameter
---	---------------

273	273 mm
400	400 mm



3	Body Material (Metal parts in contact with handled material)
---	---

F	Carbon Steel
X	Stainless Steel

4	Sensor
---	--------

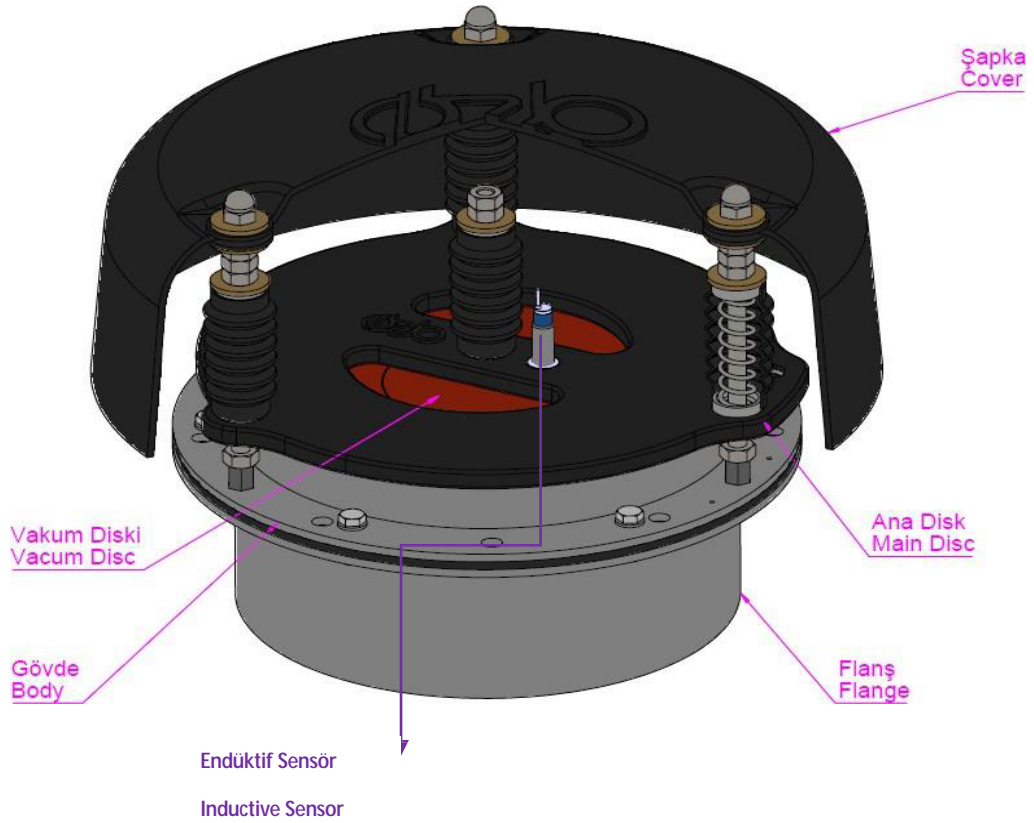
PS	Inductive Sensor included
----	---------------------------





PRESSURE RELIEF VALVE			
Carbon Steel		* Top cover: Thermoplastic * Metal parts in contact with handled material: Carbon steel * Main Disc: Carbon steel covered by EPDM * Vacuum Disc: Carbon steel covered by silicone * Flange: Included as carbon steel * Operating Temperature: -40/+120°C	
Code	Price		
PV273F	\$549.64		
PV400F	\$988.26		
Stainless Steel		* Top cover: Thermoplastic * Metal parts in contact with handled material: Stainless steel AISI 304 * Main Disc: Carbon steel covered by EPDM * Vacuum Disc: Carbon steel covered by silicone * Flange: Included as stainless steel AISI 304 * Operating Temperature: -40/+120°C	
Code	Price		
PV273X	\$1,051.96		
PV400X	\$2.05		

PRESSURE RELIEF VALVE - KIT PRICES		
Code	Quantity	Price
PV273F.010	10	\$533.26
PV273F.025	25	\$516.88
PV273F.050	50	\$504.14
PV273F.100	100	\$487.76

PRICE DIFFERENCE FOR AISI 304 STAINLESS STEEL FLANGE		
Code	Price	
PV27330001X	\$222.04	
PV40030000X	\$314.86	

PRESSURE RELIEF VALVE WITH INDUCTIVE SENSOR

Carbon Steel		<ul style="list-style-type: none"> * Top cover: Thermoplastic * Metal parts in contact with handled material: Carbon steel * Main Disc: Carbon steel covered by EPDM * Vacuum Disc: Carbon steel covered by silicone * Flange: Included as carbon steel * Inductive Sensor: Included (24...240 V AC/DC 50/60 Hz) * Switching capacity in mA: 5...200 mA DC, 5...300 mA AC * Switch ambient air temperature for operation: -25/+70°C * Switch ambient air temperature for storage: -40/+85°C 	
Code	Price		
PV273F-PS	\$1,164.80		
PV400F-PS	\$1718.08		
Stainless Steel		<ul style="list-style-type: none"> * Top cover: Thermoplastic * Metal parts in contact with handled material: Stainless steel AISI 304 * Main Disc: Carbon steel covered by EPDM * Vacuum Disc: Carbon steel covered by silicone * Flange: Included as stainless steel AISI 304 * Inductive Sensor: Included (24...240 V AC/DC 50/60 Hz) * Switching capacity in mA: 5...200 mA DC, 5...300 mA AC * Switch ambient air temperature for operation: -25/+70°C * Switch ambient air temperature for storage: -40/+85°C 	
Code	Price		
PV273X-PS	\$1,576.12		
PV400X-PS	\$2,669.94		

COVER				
Code	Price	For	Material	
PV27300100	\$121.94	PV273F PV273X	Thermoplastic	
PV40000100	\$214.76	PV400F PV400X	Thermoplastic	

MAIN DISC				
Code	Price	For	Material	
PV27300023	\$129.22	PV273F PV273X	Carbon steel covered by EPDM	
PV40000020	\$220.22	PV400F PV400X	Carbon steel covered by EPDM	

VACUUM DISC				
Code	Price	For	Material	
PV27300031	\$89.18	PV273F PV273X	Carbon steel covered by silicone	
PV40000030	\$147.42	PV400F PV400X	Carbon steel covered by silicone	

BELLOW				
Code	Price for 1 pc	For	Quantity	
PV27300060	\$14.56	PV273F PV273X	4 pcs/1 unit	



Code	Price	Technical Details	
MPG4	\$427.70	<ul style="list-style-type: none"> * Body: Galvanized * Membrane: Silicone * Activating Pressure: 400mmH2O * Voltage: AC15 - 240 (6,3A) * Operating Temperature: -25 / +75°C * Flange: included as galvanized 	
MPG4X	\$853.58	<ul style="list-style-type: none"> * Body: made of stainless steel * Membrane: Silicone * Activating Pressure: 400mmH2O * Voltage: AC15 - 240 (6,3A) * Operating Temperature: -25 / +75°C * Flange: included as made of stainless steel 	



1	2	3	4	5
BV	2F	300	N	N

1	Unit Code
---	-----------

BV	Butterfly Valve
----	-----------------

2	Type
---	------

1F	Single Flange
2F	Double Flange

3	Diameter
---	----------

100	100mm
150	150mm
200	200mm
250	250mm
300	300mm
350	350mm
400	400mm

4	Disc Type
---	-----------

N	Complete shaft covered EPDM
A	AISI304 stainless steel
C	Fe Carbon Steel

5	Seal Type
---	-----------

N	EPDM
F	Nitrile (Food contact)
V	Viton (For high temperature)

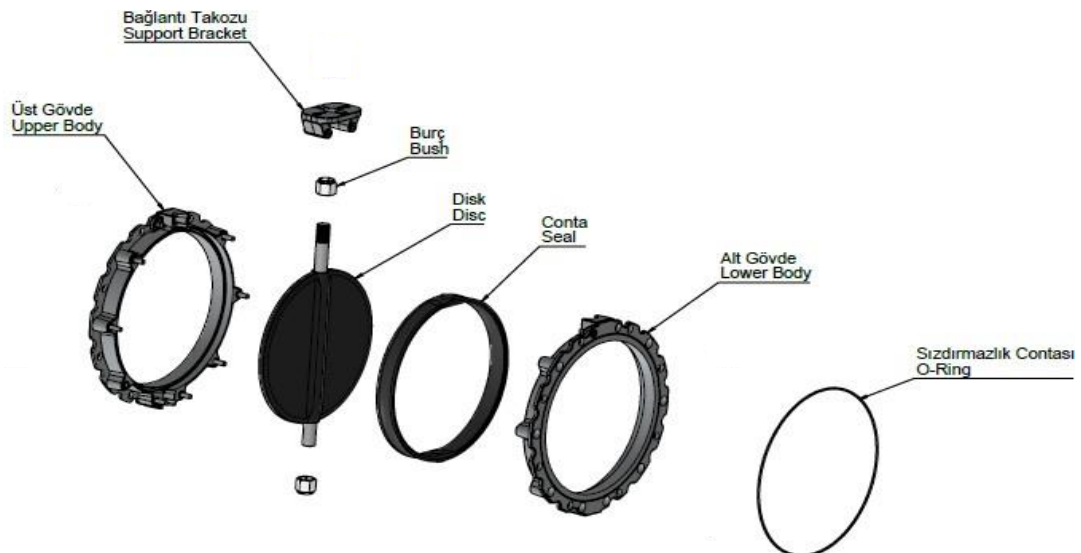

VALVES WITH EPDM DISC & EPDM SEAL

Single Flange		Double Flange		* Body: Al injection moulded * Disc: Complete disc shaft covered EPDM * Seal: EPDM * Operating Temperature: -40/+120°C * Operating Pressure: max 0,2 bar	
Code	Price	Code	Price		
BV1F100NN	\$269.36	BV2F100NN	\$262.08		
BV1F150NN	\$325.78	BV2F150NN	\$307.58		
BV1F200NN	\$358.54	BV2F200NN	\$336.70		
BV1F250NN	\$404.04	BV2F250NN	\$380.38		
BV1F300NN	\$425.88	BV2F300NN	\$414.96		
BV1F350NN	\$897.26	BV2F350NN	\$840.84		
BV1F400NN	\$1,177.54	BV2F400NN	\$1,152.06		

VALVES WITH STEEL (Fe) DISC & EPDM SEAL

Single Flange		Double Flange		* Body: Al injection moulded * Disc: Made of steel (Fe) * Seal: EPDM * Operating Temperature: -40/+120°C * Operating Pressure: max 0,2 bar	
Code	Price	Code	Price		
BV1F100CN	\$280.28	BV2F100CN	\$273.00		
BV1F150CN	\$347.62	BV2F150CN	\$325.78		
BV1F200CN	\$380.38	BV2F200CN	\$358.54		
BV1F250CN	\$425.88	BV2F250CN	\$404.04		
BV1F300CN	\$447.72	BV2F300CN	\$436.80		
BV1F350CN	\$953.68	BV2F350CN	\$897.26		
BV1F400CN	\$1,255.80	BV2F400CN	\$1,221.22		

VALVES WITH STEEL (Fe) DISC & VITON SEAL

Single Flange		Double Flange		* Body: Al injection moulded * Disc: Made of steel (Fe) * Seal: Viton * Operating Temperature: -40/+200°C * Operating Pressure: max 0,2 bar	
Code	Price	Code	Price		
BV1F100CV	\$351.26	BV2F100CV	\$342.16		
BV1F150CV	\$434.98	BV2F150CV	\$405.86		
BV1F200CV	\$476.84	BV2F200CV	\$447.72		
BV1F250CV	\$533.26	BV2F250CV	\$504.14		
BV1F300CV	\$560.56	BV2F300CV	\$546.00		
BV1F350CV	\$1,192.10	BV2F350CV	\$1,121.12		
BV1F400CV	\$1,568.84	BV2F400CV	\$1,526.98		

MANUAL ACTUATORS			
Code	Price	Ø Valve	Type Valve
ACM13	\$81.90	100-300	BV, BVFF
ACM34	\$123.76	350-400	BV



PNEUMATIC ACTUATORS			
Code	Price	Ø Valve	Type Valve
ACP13	\$385.84	100-300	BV
ACP34	\$1,112.02	350-400	BV



MICROSWITCH			
Code	Price	Ø Valve	Type Actuators
MS13	\$105.56	100-300	ACP13
MS34	\$131.04	350-400	ACP34



SOLENOID VALVE & COIL		
Code	Price	Technical Details
N31-52142400-AC	\$211.12	Solenoid Valve & Coil Set 5/2 - 1/8" solenoid valve and 24VAC 50/60Hz coil
N31-52142400-DC	\$211.12	Solenoid Valve & Coil Set 5/2 - 1/8" solenoid valve and 24VDC coil
N31-52141100-AC	\$211.12	Solenoid Valve & Coil Set 5/2 - 1/8" solenoid valve and 110VAC 50/60Hz coil
N31-52142200-AC	\$211.12	Solenoid Valve & Coil Set 5/2 - 1/8" solenoid valve and 24VDC coil
N31-52140000	\$143.97	5/2 - 1/8" solenoid valve
703806	\$47.32	24VAC bobin
703808	\$47.32	24VDC bobin
703809	\$47.32	110VAC bobin
703810	\$47.32	220 VAC bobin

3 pcs 1/8" auto coupling,
2 pcs 1/8" silencer,
2 pcs, Ø10mm, 30cm hose,
2 set bult-nut included



BVFF BUTTERFLY VALVES

1	2	3	4	5
BV	1FF	300	N	N

1	Unit Code
---	-----------

BV	Butterfly Valve
----	-----------------

2	Type
---	------

1FF	Single Flange
2FF	Double Flange

3	Diameter
---	----------



250	250mm
300	300mm

4	Disc Type
---	-----------

N	Complete shaft covered EPDM
---	-----------------------------

5	Seal Type
---	-----------

N	EPDM
---	------

BVFF BUTTERFLY VALVES			
Single Flange		BV1FF WITH UPPER SQUARE AND LOWER WITHOUT FLANGE FOR SLEEVE CONNECTION * Body: Al injection moulded * Disc: Complete disc shaft covered EPDM * Seal: EPDM * Upper Square Adaptor: Carbon steel * Operating Temperature: -40/+120°C * Operating Pressure: max 0,2 bar	
Code	Price		
BV1FF250NN	\$686.14		
BV1FF300NN	\$729.82		
Double Flange		BV2FF WITH UPPER SQUARE AND LOWER ROUND FLANGE VALVES * Body: Al injection moulded * Disc: Complete disc shaft covered EPDM * Seal: EPDM * Upper Square Adaptor: Carbon steel * Operating Temperature: -40/+120°C * Operating Pressure: max 0,2 bar	
Code	Price		
BV2FF250NN	\$653.38		
BV2FF300NN	\$687.96		

MANUAL ACTUATOR			
Code	Price	Ø Valve	
ACM13	\$81.90	100-300	



EPDM SEAL			
Stock Code	Code	Suitable Valve	Price
BV1F10000030	BVS100N	BV.F100NN	\$40.04
BV1F15000030	BVS150N	BV.F150NN	\$43.68
BV1F12000030	BVS200N	BV.F200NN	\$52.78
BV1F25000030	BVS250N	BV.F250NN	\$63.70
BV1F30000030	BVS300N	BV.F300NN	\$78.26
BV1F35000030	BVS350N	BV.F350NN	\$114.66
BV1F40000030	BVS400N	BV.F400NN	\$134.68

VITON SEAL			
Stock Code	Code	Suitable Valve	Price
BV1F10000030V	BVS100V	BV.F100AV / BV.F100CV	\$247.52
BV1F15000030V	BVS150V	BV.F150AV / BV.F150CV	\$267.54
BV1F20000030V	BVS200V	BV.F200AV / BV.F200CV	\$322.14
BV1F25000030V	BVS250V	BV.F250AV / BV.F250CV	\$393.12
BV1F30000030V	BVS300V	BV.F300AV / BV.F300CV	\$475.02
BV1F35000030V	BVS350V	BV.F350AV / BV.F350CV	\$702.52
BV1F40000030V	BVS400V	BV.F400AV / BV.F400CV	\$826.28



EPDM COATED DISC			
Stock Code	Code	Suitable Valve	Price
BV1F10010000	BVD100N	BV.F100NN	\$114.66
BV1F15010000	BVD150N	BV.F150NN	\$136.50
BV1F25010000	BVD200N	BV.F200NN	\$187.46
BV1F25010000	BVD250N	BV.F250NN	\$225.68
BV1F30010000	BVD300N	BV.F300NN	\$276.64
BV1F35010001	BVD350N	BV.F350NN	\$442.26
BV1F40010001	BVD400N	BV.F400NN	\$553.28

STEEL (Fe) DISC			
Stock Code	Code	Suitable Valve	Price
BV1F10031000	BVD100C	BV.F100CN / BV.F100CV	\$121.94
BV1F15031000	BVD150C	BV.F150CN / BV.F150CV	\$143.78
BV1F20031000	BVD200C	BV.F200CN / BV.F200CV	\$198.38
BV1F25031000	BVD250C	BV.F250CN / BV.F250CV	\$240.24
BV1F30031000	BVD300C	BV.F300CN / BV.F300CV	\$293.02
BV1F35031000	BVD350C	BV.F350CN / BV.F350CV	\$469.56
BV1F40031000	BVD400C	BV.F400CN / BV.F400CV	\$586.04

VALVE BUSH			
Stock Code	Code	Ø Valve	Price
BV1F10000040	62022	100-300	\$12.74
BV1F35000040	62028	350-400	\$18.20



SUPPORT BRACKET FOR ACTUATOR			
Stock Code	Code	Ø Valve	Price
BV1F10000050	BVR022	100-300	\$67.34
BV1F35000050	BVR028	350-400	\$101.92



1	2	3	4	5	6
SV	Q	150	1	3	A

1	Unit Code
---	-----------

SV	Slide Valve
----	-------------

2	Type
---	------

Q	Square Section
C	Round Section
R	Rectangular Section

3	Nominal Valve Size
---	--------------------

150	150 mm
200	200 mm
250	250 mm
300	300 mm
350	350 mm
400	400 mm

4	Body Material
---	---------------

1	Galvanized
2	Stainless Steel AISI 304
3	Stainless Steel AISI 316

5	Chute Material
---	----------------

1	Carbon Steel
2	Stainless Steel AISI 304
3	EPDM

6	Blade Material
---	----------------

A	Galvanized
B	Stainless Steel AISI 304
C	Stainless Steel AISI 316
H	Hardox

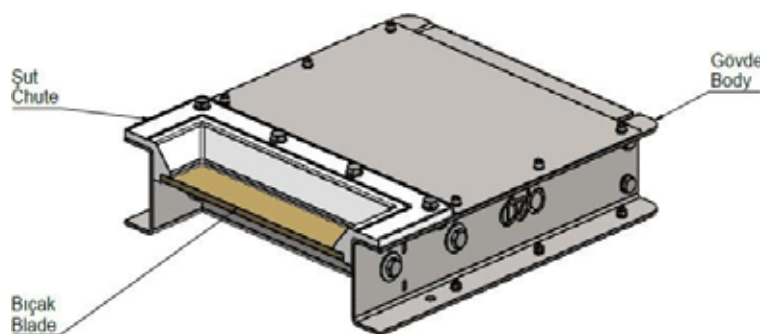

SVQ SQUARE SECTION SLIDE VALVES



Code	Price	
SVQ15013A	\$549.64	* Body: Galvanized * Chute: EPDM * Blade: Galvanized * Seal Block: Carbon steel covered by EPDM * Operating Temperature: -40/+120°C
SVQ20013A	\$611.52	
SVQ25013A	\$713.44	
SVQ30013A	\$846.30	
SVQ35013A	\$1,050.14	
SVQ40013A	\$1,233.96	
Code	Price	
SVQ15013B	\$671.58	* Body: Galvanized * Chute: EPDM * Blade: Stainless steel AISI 304 * Seal Block: Carbon steel covered by EPDM * Operating Temperature: -40/+120°C
SVQ20013B	\$778.96	
SVQ25013B	\$877.24	
SVQ30013B	\$1,081.08	
SVQ35013B	\$1,324.96	
SVQ40013B	\$1,625.26	
Code	Price	
SVQ15023B	\$888.16	* Body: Stainless Steel AISI 304 * Chute: EPDM * Blade: Stainless steel AISI 304 * Seal Block: Carbon steel covered by EPDM * Operating Temperature: -40/+120°C
SVQ20023B	\$1,079.26	
SVQ25023B	\$1,232.14	
SVQ30023B	\$1,672.58	
SVQ35023B	\$1,940.12	
SVQ40023B	\$2,225.86	

*** Price Difference for Hardox Blade: SVQ...13A + % 15

*** For Hardox Blade; Please ask for delivery time form Production Planning.

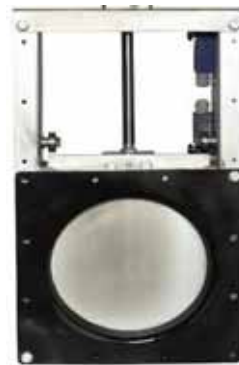

Code	Price	
SVC15013A	\$627.90	* Body: Galvanized * Chute: EPDM * Blade: Galvanized * Seal Block: Carbon steel covered by EPDM * Operating Temperature: -40/+120°C
SVC20013A	\$693.42	
SVC25013A	\$804.44	
SVC30013A	\$979.16	
SVC35013A	\$1,223.04	
SVC40013A	\$1,335.88	
Code	Price	
SVC15013B	\$700.70	* Body: Galvanized * Chute: EPDM * Blade: Stainless steel AISI 304 * Seal Block: Carbon steel covered by EPDM * Operating Temperature: -40/+120°C
SVC20013B	\$817.18	
SVC25013B	\$944.58	
SVC30013B	\$1,101.10	
SVC35013B	\$1,363.18	
SVC40013B	\$1,645.28	
Code	Price	
SVC15023B	\$955.50	* Body: Stainless Steel AISI 304 * Chute: EPDM * Blade: Stainless steel AISI 304 * Seal Block: Carbon steel covered by EPDM * Operating Temperature: -40/+120°C
SVC20023B	\$1,099.28	
SVC25023B	\$1,290.38	
SVC30023B	\$1,634.36	
SVC35023B	\$2,125.76	
SVC40023B	\$2,378.74	

*** Price Difference for Hardox Blade: SVC...13A + % 15

*** For Hardox Blade; Please ask for delivery time form Production Planning.

SVC RECTANGULAR SECTION SLIDE VALVES

Code	Price	
SVR20013A	\$1,375.92	* Body: Galvanized * Chute: EPDM * Blade: Galvanized * Seal Block: Carbon steel covered by EPDM * Operating Temperature: -40/+120°C
SVR30013A	\$1,477.84	
Code	Price	
SVR20013B	\$1,490.58	* Body: Galvanized * Chute: EPDM * Blade: Stainless steel AISI 304 * Seal Block: Carbon steel covered by EPDM * Operating Temperature: -40/+120°C
SVR30013B	\$1,587.04	
Code	Price	
SVR20023B	\$3,028.48	* Body: Stainless Steel AISI 304 * Chute: EPDM * Blade: Stainless steel AISI 304 * Seal Block: Carbon steel covered by EPDM * Operating Temperature: -40/+120°C
SVR30023B	\$3,354.26	

*** Price Difference for Hardox Blade: SVR...13A + % 15

*** For Hardox Blade; Please ask for delivery time form Production Planning.

**EXTRA PRICE FOR SEAL BLOCK FOR HIGH TEMPERATURE
(MAX 200°C)**

Suitable Valve	Price	
SV Q-C 150	\$946.40	
SV Q-C-R 200	\$1,055.60	
SV Q-C 250	\$1,119.30	
SV Q-C-R 300	\$1,173.90	
SV Q-C 350	\$1,264.90	
SV Q-C 400	\$1,374.10	

**EXTRA PRICE FOR SEAL BLOCK
PVC- WHITE**

Suitable Valve	Price
SV Q-C 150	\$473.20
SV Q-C-R 200	\$527.80
SV Q-C 250	\$564.20
SV Q-C-R 300	\$573.30
SV Q-C 350	\$637.00
SV Q-C 400	\$691.60

MANUAL ACTUATORS

Code	Suitable Valve	Price	
ACMS150	SV Q-C 150	\$380.38	
ACMS200	SV Q-C-R 200	\$391.30	
ACMS250	SV Q-C 250	\$400.40	
ACMS300	SV Q-C-R 300	\$424.06	
ACMS350	SV Q-C 350	\$449.54	
ACMS400	SV Q-C 400	\$449.54	

GEARBOX FOR ACMS MANUAL ACTUATORS

Code	Suitable Actuator	Price	
ACMS-R	ACMS150	\$1277.64	
	ACMS200		
	ACMS250		
	ACMS300		
	ACMS350		
	ACMS400		

NOTE: Please add on the suitable ACMS price.

ELECTROMECHANICAL ACTUATORS

Code	Suitable Valve	Motor Power	Price	
ACES150	SVQ-C 150	0,37 kW	\$1,654.38	
ACES200	SVQ-C-R 200	0,37 kW	\$1,667.12	
ACES250	SVQ-C 250	0,37 kW	\$1,699.88	
ACES300	SVQ-C-R 300	0,37 kW	\$1,712.62	
ACES350	SVQ-C 350	0,37 kW	\$1,772.68	
ACES400	SVQ-C 400	0,37 kW	\$1,821.82	

PNEUMATIC ACTUATORS			
Code	Suitable Valve	Ø / Stroke Cylinder	Price
ACPS150	SVQ-C 150	63 mm / 140 mm	\$416.78
ACPS200	SVQ-C 200	80 mm / 200 mm	\$653.38
ACPS250	SVQ-C 250	80 mm / 250 mm	\$698.88
ACPS300	SVQ-C 300	80 mm / 300 mm	\$728.00
ACPS350	SVQ-C 350	100 mm / 350 mm	\$950.04
ACPS400	SVQ-C 400	100 mm / 400 mm	\$1,048.32
ACPS400-1	SVQ-C 400	125 mm / 400 mm	\$1,228.50



ON / OFF LIMIT SWITCH			
Code	Price	Details	For
ACES001	\$200.20	On / off 2 pcs 1 set	ACES ACPS

CONNECTION SET FOR PNEUMATIC CYLINDER JOINT OF SLIDE VALVE		
Code	Suitable Valve	Price
ACPS15000020	SV Q-C 150	\$61.88
ACPS20000010	SV Q-C-R 200 SV Q-C 250 SV Q-C-R 300	\$83.72
ACPS35000030	SV Q-C 350 SV Q-C 400	\$103.74

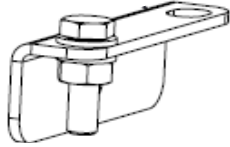

IF THE PNEUMATIC CYLINDER IS TO BE SUPPLIED BY THE USER, CONNECTION SET MUST BE TAKEN FOR ASSEMBLY.

EPDM CHUTE (OLD VERSION)

Suitable Valve	SVQ Square Section		SVC Round Section		SVR Rectangular Section	
	Code	Price	Code	Price	Code	Price
150	SVQ15013010	\$191.10	SVC15013010	\$218.40	-	-
200	SVQ20013010	\$209.30	SVC20013010	\$231.14	SVR20013010	\$269.36
250	SVQ25013010	\$258.44	SVC25013010	\$287.56	-	-
300	SVQ30013010	\$349.44	SVC30013010	\$369.46	SVR30013010	\$427.70
350	SVQ35013010	\$391.30	SVC35013010	\$413.14	-	-
400	SVQ40013010	\$420.42	SVC40013010	\$442.26	-	-

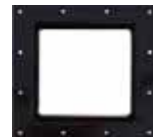

NOTE: OLD VERSIONS ARE LIMITED IN STOCK. OLD AND NEW VERSIONS ARE INTERCHANGEABLE.

EPDM CHUTE (NEW VERSION)

Suitable Valve	SVQ Square Section		SVC Round Section	
	Code	Price	Code	Price
150	SV15000060	\$191.10	SV15000070	\$218.40
200	SV20000040	\$209.30	SV20000050	\$231.14
250	SV25000040	\$258.44	SV25000050	\$287.56
300	SV30000060	\$349.44	SV30000070	\$369.46
350	SV35000040	\$391.30	SV35000050	\$413.14
400	SV40000040	\$420.42	SV40000050	\$442.26

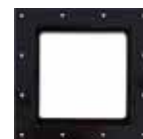

SEAL BLOCK (OLD VERSION)

SEAL BLOCK (NEW VERSION)

Suitable Valve	EPDM		Suitable Valve	EPDM	
	Code	Price		Code	Price
150	SVB15000040	\$209.30	150	SV15003000	\$209.30
200	SVB20000040	\$218.40	200	SV20030000	\$218.40
250	SVB25000040	\$273.00	250	SV25020000	\$273.00
300	SVB30000040	\$364.00	300	SV30020000	\$364.00
350	SVB35000040	\$400.40	350	SV35030000	\$400.40
400	SVB40000040	\$436.80	400	SV40030000	\$436.80

OLD AND NEW VERSIONS ARE NOT INTERCHANGEABLE

ACMS HOLDER BLOCK (OLD VERSION)		ACMS HOLDER BLOCK (NEW VERSION)		For	OLD AND NEW VERSIONS ARE NOT INTERCHANGEABLE
Code	Price	Code	Price		
ACMS30000030	\$136.50	ACMS15000030	\$136.50	ACMS150 ACMS200 ACMS250 ACMS300	
ACMS40000035	\$154.70	ACMS35000020	\$154.70	ACMS350 ACMS400	

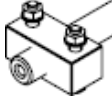
ACES HOLDER BLOCK (NEW VERSION)			
Code	For	Price	
ACES15000030	ACES150 ACES200 ACES250 ACES300	\$145.60	
ACES35000020	ACES350 ACES400	\$154.70	

GEARBOX (NEW VERSION)				
Code	Type	For	Price	
RDSV01000-4	P045 Motor size: 71 Gear ratio: 1/21, 67 rpm Flange: B14	ACES	\$562.38	

ELECTRIC MOTOR					
Code	Power	Size	Efficiency Class	Price	
N90-0451064	0,37 kW	71 M B14	IE2	\$367.64	

1	2	3	4	5
RV	200	D	150	460

1	Unit Code
---	-----------

RV	Rotary Valve
----	--------------

2	Body size
---	-----------

200	200
250	250
300	300
350	350

3	Drive group connection type
---	-----------------------------

D	Direct Drive
V	Mechanical Variator
C	Chain

4	Motor Power
---	-------------

150	1,5 kW
075	0,75 kW
055	0,55 kW
XXX	Motor Excluded

5	Gearbox ratio
---	---------------

096	1/96 15 rpm
067	1/67 21 rpm
046	1/46 30 rpm
038	1/38 37 rpm

ROTARY VALVES WITHOUT DRIVE GROUP

Code	Lt/rpm	Price	Body: GGG50 nodular cast iron Rotor: GGG50 nodular cast iron
RV 200	5	\$2,857.40	
RV 250	9	\$3,432.52	
RV 300	19	\$4,144.14	
RV 350	29	\$4,919.46	



ROTARY VALVES WITH DRIVE GROUP

Code	Nominal Revolution	Motor Power	Nominal Capacity ***	Price
RV 200 D 055 096	15 rpm	0,55 kW	4 m ³ /h	\$5,166.98
RV 200 D 075 067	21 rpm	0,75 kW	6 m ³ /h	\$5,223.40
RV 200 D 150 046	30 rpm	1,5 kW	9 m ³ /h	\$5,429.06
RV 200 D 150 038	37 rpm	1,5 kW	11 m ³ /h	\$5,816.72
RV 250 D 055 096	15 rpm	0,55 kW	8 m ³ /h	\$5,767.58
RV 250 D 075 067	21 rpm	0,75 kW	11 m ³ /h	\$5,820.36
RV 250 D 150 046	30 rpm	1,5 kW	16 m ³ /h	\$6,036.94
RV 250 D 150 038	37 rpm	1,5 kW	20 m ³ /h	\$6,457.36
RV 300 D 055 096	15 rpm	0,55 kW	17 m ³ /h	\$6,535.62
RV 300 D 075 067	21 rpm	0,75 kW	24 m ³ /h	\$6,561.10
RV 300 D 150 046	30 rpm	1,5 kW	34 m ³ /h	\$6,786.78
RV 300 D 150 038	37 rpm	1,5 kW	42 m ³ /h	\$7,258.16
RV 350 D 055 096	15 rpm	0,55 kW	26 m ³ /h	\$7,303.66
RV 350 D 075 067	21 rpm	0,75 kW	36 m ³ /h	\$7,330.96
RV 350 D 150 046	30 rpm	1,5 kW	52 m ³ /h	\$7,558.46
RV 350 D 150 038	37 rpm	1,5 kW	64 m ³ /h	\$8,078.98



*** Nominal capacities for air at 100% filling ratio.

PRICE DIFFERENCE FOR MECHANICAL VARIATOR (4-22 rpm)

Code	Gear Ratio	Motor Power	Price
MF010	1/96	0,55 kW	\$2,908.36
	1/67	0,75 kW	
MF020	1/46	1,5 kW	\$4,000.36
	1/38	1,5 kW	



PRICE DIFFERENCE FOR PROXIMITY SWITCH

Code	Price
PNVC10000030	\$358.54



ROTARY VALVES WITH GEARBOX WITHOUT ELECTRIC MOTOR

Code	Nominal Revolution	Electric Motor	Price
RV 200 D XXX 096	15 rpm	Excluded	\$4,908.54
RV 200 D XXX 067	21 rpm	Excluded	\$4,963.14
RV 200 D XXX 046	30 rpm	Excluded	\$5,157.88
RV 200 D XXX 038	37 rpm	Excluded	\$5,525.52
RV 250 D XXX 096	15 rpm	Excluded	\$5,480.02
RV 250 D XXX 067	21 rpm	Excluded	\$5,529.16
RV 250 D XXX 046	30 rpm	Excluded	\$5,734.82
RV 250 D XXX 038	37 rpm	Excluded	\$6,133.40
RV 300 D XXX 096	15 rpm	Excluded	\$6,208.02
RV 300 D XXX 067	21 rpm	Excluded	\$6,231.68
RV 300 D XXX 046	30 rpm	Excluded	\$6,448.26
RV 300 D XXX 038	37 rpm	Excluded	\$6,894.16
RV 350 D XXX 096	15 rpm	Excluded	\$6,937.84
RV 350 D XXX 067	21 rpm	Excluded	\$6,965.14
RV 350 D XXX 046	30 rpm	Excluded	\$7,179.90
RV 350 D XXX 038	37 rpm	Excluded	\$7,674.94



GEARBOX				
Code	Type	Suitable Valve	Price	
RDRV12010	P085 Motor size: 80 Gear ratio: 1/96, 15 rpm Flange: B14	RV 200 RV 250 RV 300 RV 350	\$1,576.12	
RDRV10010	P085 Motor size: 80 Gear ratio: 1/67, 21 rpm Flange: B14	RV 200 RV 250 RV 300 RV 350	\$1,617.98	
RDRV01010	P085 Motor size: 90L Gear ratio: 1/46, 30 rpm Flange: B14	RV 200 RV 250 RV 300 RV 350	\$1,658.02	
RDRV11010	P085 Motor size: 90L Gear ratio: 1/38, 37 rpm Flange: B14	RV 200 RV 250 RV 300 RV 350	\$1,739.92	

ELECTRIC MOTOR					
Code	Power	Size	Eff. Class	Price	
	0,55 kW	80 B14	IE2	\$447.72	
	0,75 kW	80 B14	IE3	\$589.68	
	1,5 kW	90 B14	IE3	\$842.66	



PINCH VALVE			
Code	Price		
PNV100	\$1,141.14	<ul style="list-style-type: none"> * Body: Aluminium * Sleeve: Abrasion resistant and made of Staltic NR-BR-SBR composition. * Flanges: PN10, Aluminium. * Material Temperature: -20°C / 80°C * Operating Temperature: Max +50°C * Nominal operating pressure: Max 4 bar * Control pressure: Max 6 bar * Pressure difference for valve closing: ΔP 1,5 bar 	

SILOBUS CONNECTION ELEMENT			
Code	Price		
PNVC100	\$729.82	<p>Made of carbon steel, supplied complete with bolt & nuts for assembly and inductive sensor.</p> <p>PNVC1000050 (made of S235JR) Silo hose connection flange included</p>	

CONTROL PANEL			
Code	Price		
PNVPLC	\$667.94	<ul style="list-style-type: none"> * System Pressure: max 6 bar * Operating Pressure: 8 bar * Electrical Connection: 24VDC 	



LPC CODE KEY



1	2
LP	024DC

1	Unit Code
---	-----------

LP	Level Indicator
----	-----------------

2	voltage
---	---------

024AC	24VAC 50/60Hz
110AC	110VAC 50/60Hz
220AC	220VAC 50/60 Hz
024DC	24VDC

Code	Voltage	Price	Technical Specifications
LP220AC	220VAC 50/60Hz	\$280.28	* Body: Aluminium injection moulded * Shaft and paddle: made of stainless steel * Sensitive adjustment: with 3 positions * Protection class: IP66 * Connector: included
LP024AC	24VAC 50/60Hz	\$280.28	
LP110AC	110VAC 50/60Hz	\$280.28	
LP024DC	24VDC	\$356.72	



LP024DC - KIT PRICES		
Code	Quantity	Price
LP024DC.010	10	\$314.86
LP024DC.050	50	\$300.30
LP024DC.100	100	\$274.82

PIPE EXTENDED SHAFT			
Code	Length mm	Price	Material
LP22090100	100	\$30.94	Aluminium
LP22090200	200	\$30.94	
LP22090300	300	\$30.94	
LP22090400	400	\$32.76	
LP22090500	500	\$32.76	
LP22090600	600	\$34.58	
LP22090700	700	\$34.58	
LP22090800	800	\$45.50	
LP22090900	900	\$45.50	
LP22091000	1000	\$45.50	



FLEXIBLE EXTENDED SHAFT			
Code	Length mm	Price	Material
LP22090501	500	\$80.08	Stainless steel
LP22091001	1000	\$94.64	



Code	Price		Technical Details	
AJ25	\$45.50	1 pc	* Pressure: 0 - 0,5 bar * Air Consumption: 0,04-0,06 m ³ /h @ 0,2 bar * Material: Plastic Body & sinter filter * Connector: Fe included	
	\$382.20	Package price for 10* pcs		
	\$3,276.00	Package price for 100** pcs		
AJ26	\$76.44	1 pc	* Pressure: 0 - 4 bar * Air Consumption: 0,15-0,25 m ³ /h @ 4 bar * Material: Plastic Body & stainless steel filter * Connector: Fe included	
	\$728.00	Package price for 10* pcs		
	\$6,734.00	Package price for 100** pcs		

CONNECTOR AS A SPARE PARTS				
Code	Price	For	Material	
AJ2502000	\$20.02	AJ25 AJ26	Fe	



1	2	3	4	5	6	7
SEC	1	18	12	1	DS	0

1	Unit Code
---	-----------

SEC

2	Body Material (Metal parts in contact with handled material)
---	---

1	Carbon Steel
2	Stainless Steel

3	Body Diameter
---	---------------

10	1.000 mm
15	1.500 mm
18	1.800 mm
21	2.100 mm

4	Suspension Quantity
---	---------------------

4	4 pcs
8	8 pcs
12	12 pcs
18	18 pcs

5	Vibrator
---	----------

0	Excluded
1	Included

6	Deflector Type
---	----------------

DS	Standard
D3	30°
D4	45°

7	Manual Emergency Gate Valve
---	-----------------------------

0	Excluded
1	Included

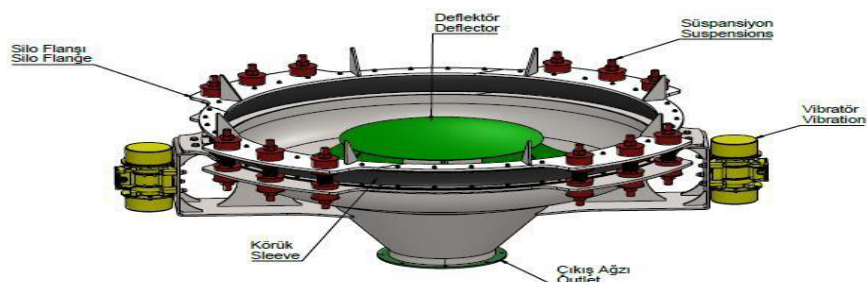

SEC CARBON STEEL BIN ACTIVATORS



METAL PARTS IN CONTACT WITH HANDLED MATERIAL MADE OF CARBON STEEL							
Code	Diameter	Vibrator	Seal	Outlet	Suspension	Silo Flange	Price
SEC.1.10.04	1.000mm	1 pc EVM 200/15	EPDM Black	323mm cylindrical with flange for 300mm butterfly valve	4	Included	\$5,869.50
SEC.1.15.08	1.500mm	1 pc EVM 750/15	EPDM Black	419mm cylindrical with flange for 400mm butterfly valve	8	Included	\$12,124.84
SEC.1.18.12	1.800mm	2 pcs EVM 750/15	EPDM Black		12	Included	\$16,296.28
SEC.1.21.18	2.100mm	2 pcs EMV 750/15	EPDM Black		18	Included	\$21,084.70



METAL PARTS IN CONTACT WITH HANDLED MATERIAL MADE OF STAINLESS STEEL (AISI 304)

Code	Diameter	Vibrator	Seal	Outlet	Suspension	Silo Flange	Price
SEC.2.10.04	1.000mm	1 pc EVM 200/15	EPDM Black	323mm cylindrical with flange for 300mm butterfly valve	4	Included	\$10,907.26
SEC.2.15.08	1.500mm	1 pc EVM 750/15	EPDM Black	419mm cylindrical with flange for 400mm butterfly valve	8	Included	\$22,327.76
SEC.2.18.12	1.800mm	2 pcs EVM 750/15	EPDM Black		12	Included	\$30,399.46
SEC.2.21.18	2.100mm	2 pcs EMV 750/15	EPDM Black		18	Included	\$41,936.44

CONICAL ADAPTOR FOR OUTLET				
Code	ØB - ØA	H mm	Price Fe	Price AISI 304
SCS07007030	C200 - C300		\$182.00	\$364.00
SCS07007040	C250 - C300	110	\$209.30	\$418.60
SCS07007050	C300 - C350	110	\$254.80	\$509.60
	C300 - C400	110	\$336.70	\$673.40
	C350 - C400		\$354.90	\$709.80

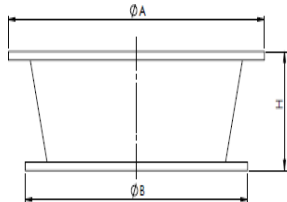

*** Please specify the paint code as RAL7035 on the order/request (for carbon steel options).

FLANGE FOR SLIDE VALVES			
Code	Ø Valve	Price Fe	Price AISI 304
SC.F.SVC.300	(SVC) 300	\$200.20	\$400.40
SC.F.SVC.400	(SVC) 400	\$218.40	\$436.80





*** Please specify the paint code as RAL7035 on the order/request (for carbon steel options).

DEFLECTOR OPTIONS			
Code	Ø Bin Activator	Price Fe	Price AISI
D30.1.10	1000	\$606.06	\$1,024.66
D30.1.15	1500	\$1,066.52	\$1,801.80
D30.1.18	1800	\$1,317.68	\$2,227.68
D30.1.21	2100	\$1,577.94	\$2,666.30
Code	Ø Bin Activator	Price Fe	Price AISI
D30.2.10	1000	\$629.72	\$1,064.70
D30.2.15	1500	\$1,124.76	\$1,900.08
D30.2.18	1800	\$1,357.72	\$2,295.02
D30.2.21	2100	\$1,663.48	\$2,811.90

AJ 25 FLUIDISATION NOZZLE APPLICATION		
On Cone Wall For 1 pc	On Deflector For 1 pc	
\$70.98	\$81.90	

MANUAL EMERGENCY GATE VALVE			
Ø Bin Activator	Material	Price	
1.000	Carbon Steel	\$620.62	
1.500		\$811.72	
1.800		\$926.38	
2.100		\$959.14	
1.000	Stainless Steel AISI304	\$926.38	
1.500		\$1,213.94	
1.800		\$1,385.02	
2.100		\$1,543.36	

SEAL (OLD VERSION-PVC-WHITE)				 <p>OLD AND NEW VERSIONS ARE NOT INTERCHANGEABLE</p>
Code	Ø Bin Activator	Material	Price	
SEC11000051	1000	PVC	\$1,197.56	
SEC11500051	1500	PVC	\$1,488.76	
SEC11800051	1800	PVC	\$1,648.92	

SEAL (NEW VERSION)				 <p>OLD AND NEW VERSIONS ARE NOT INTERCHANGEABLE</p>
Code	Ø Bin Activator	Material	Price	
SEC1000010	1000	EPDM	\$1,106.56	
SEC1500010	1500	EPDM	\$1,370.46	
SEC1800010	1800	EPDM	\$1,634.36	
SEC2100010	2100	EPDM	\$2,540.72	

SUSPENSIONS			
Code	Ø Bin Activator	1 Set Price	
SEC1030000	1.000 1.500 1.800 2.100	\$556.92	

VIBRATOR						
Code	Revolution	Centrifugal Force	Power	Voltage	Price	
EVM 200/15	1.500 rpm	214 kg	0,18 kW	230-400V 50Hz	\$476.84	
EVM 750/15	1.500 rpm	735 kg	0,47 kW	230-400V 50Hz	\$895.99	

1	2	3	4	5	6	7
BBU	15	F	1	1	0	0

1	Unit code	BBU	
2	Max big bag weight	15	1 & 1,5 ton
3	Metal parts in contact with handled material	F	Galvanized
		X	Stainless steel
4	Extendable telescopic upper frame	0	Excluded
		1	Included
5	Control panel	0	Excluded
		1	Included
6	FIBC cutting blade	0	Excluded
		1	Included
7	Adjustable pneumatic arms	0	Excluded
		1	Included

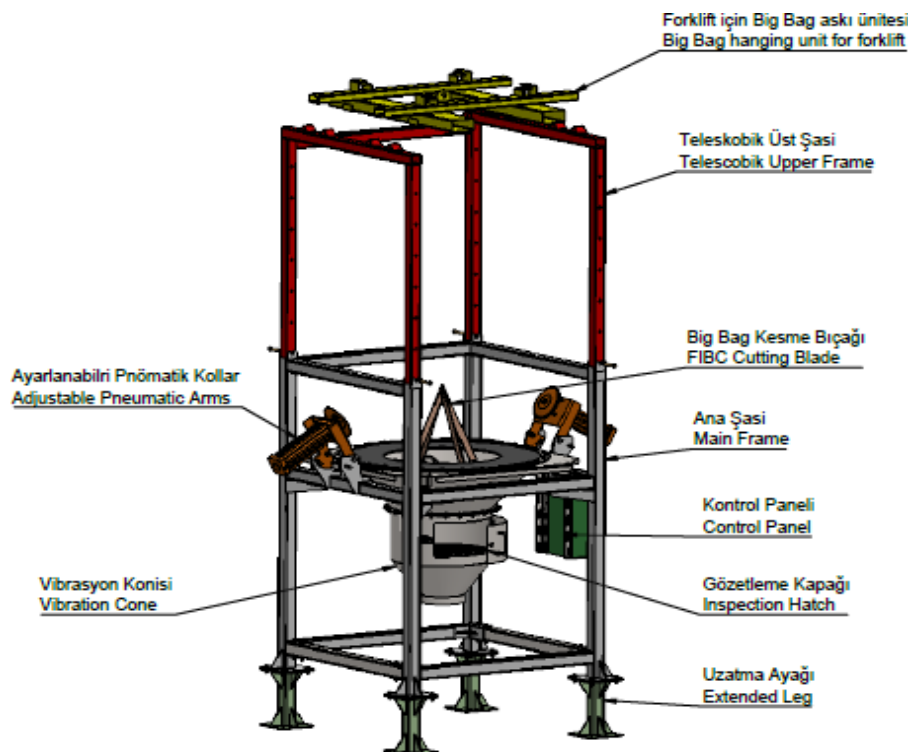

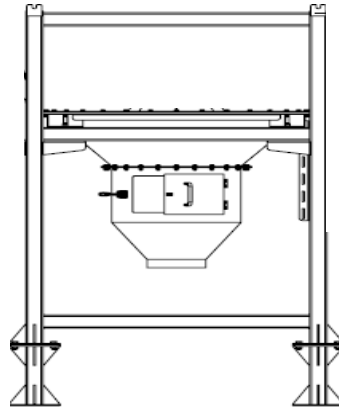

MATERIALS IN CONTACT METAL PARTS GALVANIZED WITHOUT TELESCOPIC UPPER FRAME		
Code	Price	
BBU.15.F.0	\$11,739.00	<ul style="list-style-type: none"> * Main frame: made of carbon steel, RAL 5010 * Upper frame: excluded * Vibrating cone: galvanized with inspection hatch and outlet Ø273mm * Vibrator: EVM-M 130/3 Monophase * Control board: excluded (optional) * Cutting blade: excluded (optional) * Adjustable pneumatic pistons: excluded (optional) * Winch: excluded

MATERIALS IN CONTACT METAL PARTS STAINLESS STEEL WITHOUT TELESCOPIC UPPER FRAME		
Code	Price	
BBU.15.X.0	\$16,434.60	<ul style="list-style-type: none"> * Main frame: made of carbon steel, RAL 5010 * Upper frame: excluded * Vibrating cone: made of AISI 304 with inspection hatch and outlet Ø273mm * Vibrator: EVM-M 130/3 Monophase * Control board: excluded (optional) * Cutting blade: excluded (optional) * Adjustable pneumatic pistons: excluded (optional) * Winch: excluded

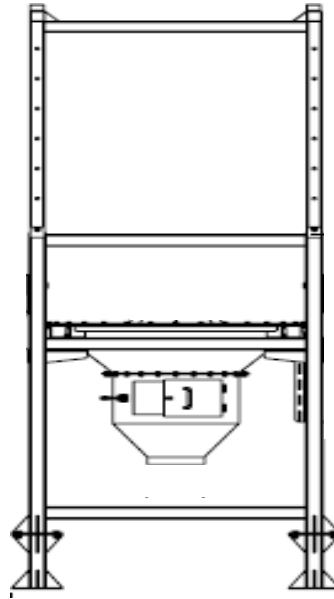

MATERIALS IN CONTACT METAL PARTS GALVANIZED WITH TELESCOPIC UPPER FRAME		
Code	Price	
BBU.15.F.1	\$15,393.56	<ul style="list-style-type: none"> * Main frame: made of carbon steel, RAL 5010 * Upper frame: extendable telescopic upper frame with base frame for forklift/Winch loading, made of carbon steel * Vibrating cone: galvanized with inspection hatch and outlet Ø273mm * Vibrator: EVM-M 130/3 Monophase * Control board: excluded (optional) * Cutting blade: excluded (optional) * Adjustable pneumatic pistons: excluded (optional) * Winch: excluded

MATERIALS IN CONTACT METAL PARTS STAINLESS STEEL WITH TELESCOPIC UPPER FRAME		
Code	Price	
BBU.15.X.1	\$22,320.48	<ul style="list-style-type: none"> * Main frame: made of carbon steel, RAL 5010 * Upper frame: extendable telescopic upper frame with base frame for forklift/Winch loading, made of carbon steel * Vibrating cone: made of AISI 304 with inspection hatch and outlet Ø273mm * Vibrator: EVM-M 130/3 Monophase * Control board: excluded (optional) * Cutting blade: excluded (optional) * Adjustable pneumatic pistons: excluded (optional) * Winch: excluded

FLANGE FOR BUTTERFLY VALVES			
Code	Ø Valve	Price Galvanized	Price AISI 304
SC.F.BV.250	BV.250	\$167.44	\$278.46



FLANGE FOR SLIDE VALVES			
Code	Ø Valve	Price Galvanized	Price AISI 304
SC.F.SVC.250	(SVC) 250	\$225.68	\$374.92



CONICAL ADAPTOR WITH ROUND FLANGES			
Code	ØB - ØA	Price Galvanized	Price AISI 304
SCS07007020	C200 - C250	\$185.64	\$307.58
SCS07007040	C250 - C300	\$251.16	\$416.78



IRIS VALVE		
Code	Price	
	+ \$3,599.96	300mm in Aluminium with PU coated Polyester Diaphragm

CONTROL BOARD		
Code	Price	
BBU.CP	\$1,228.50	Programmable electric/electronic and pneumatic control board, 230V 50 Hz



FIBC CUTTING BLADE		
Code	Material	Price
BBU.CB.1	Fe	\$637.00
BBU.CB.2	AISI	\$886.34



MANUAL ADJUSTABLE PNEUMATIC ARMS		
Code	Price	
BBU.PA	\$1,801.80	2 pcs / 1 set



BIG BAG HANGING UNIT FOR FORKLIFT LOADING	
Code	Price
BBU.HU	\$1,259.44



VIBRATOR (MAX DISCOUNT 20%)					
Code	Revolution	Centrifugal Force	Power	Voltage	Price
EVM-M 130/3	3000 rpm	165 kg	0,20 kW	220 V Monophase	\$373.10



1	2	3	4
MBOS	095	304	1,1

1	Unit Code
---	-----------

MBOS

2	Bag Inlet Door Width
---	----------------------

095	950 mm
125	1250 mm

3	Body Material (Metal parts in contact with handled material)
---	---

430	AISI 430 Stainless Steel
304	AISI 304 Stainless Steel
316	AISI 316 Stainless Steel

4	Fan Motor Power
---	-----------------

X	Without
0,75	0,75 kW
1,1	1,1 kW

5	Hopper
---	--------

0	Without
1	Included

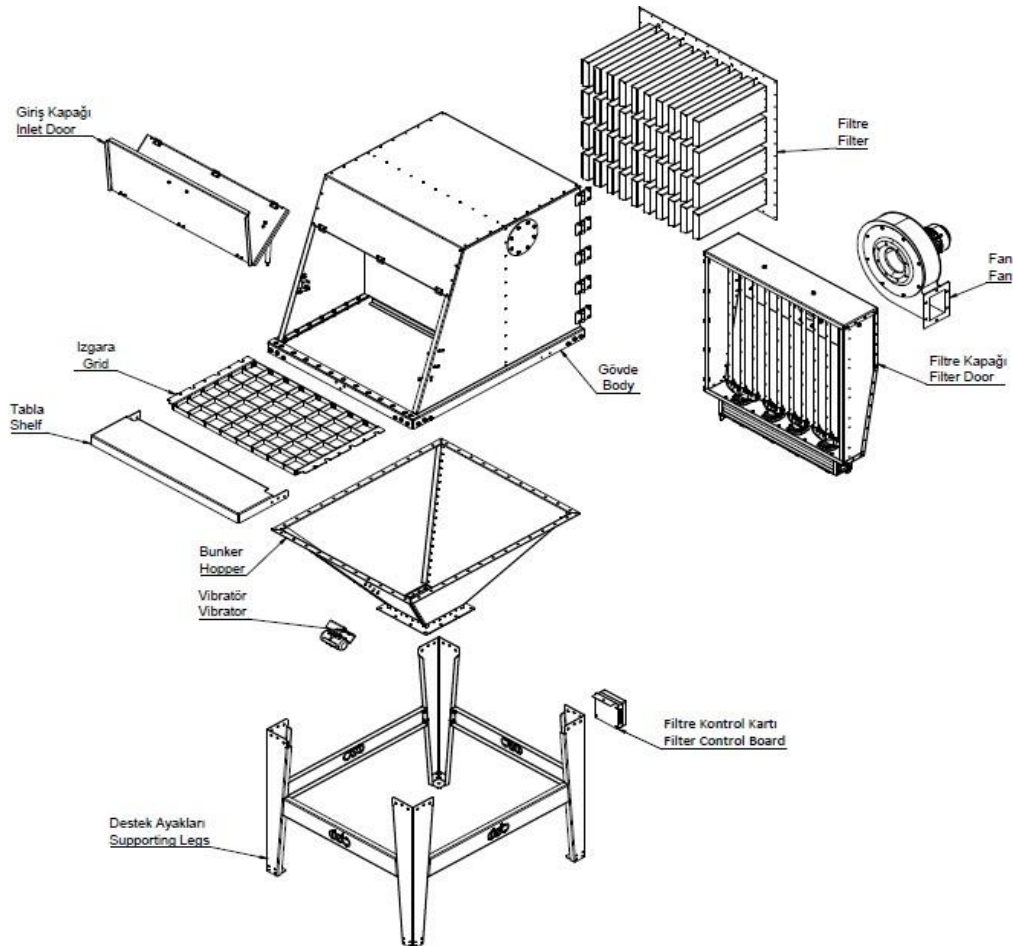

MAIN UNIT WITHOUT HOPPER

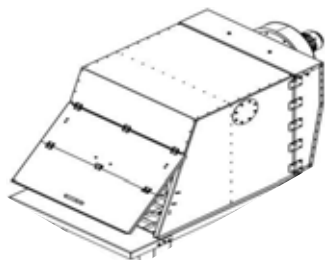
Code	Material	Price		
MBOS.095.430.X.0	AISI 430	\$16,787.68	Main unit with; * 0,75 kW fan * Bag inlet door switch * 10 m ² filter with horizontally mounted elliptical bags * Filter control board included. * Hopper excluded	
MBOS.095.304.X.0	AISI 304	\$18,713.24		
MBOS.095.316.X.0	AISI 316	\$25,864.02		
MBOS.125.430.X.0	AISI 430	\$19,304.74		
MBOS.125.304.X.0	AISI 304	\$21,519.68		
MBOS.125.316.X.0	AISI 316	\$29,744.26		

MAIN UNIT WITH HOPPER

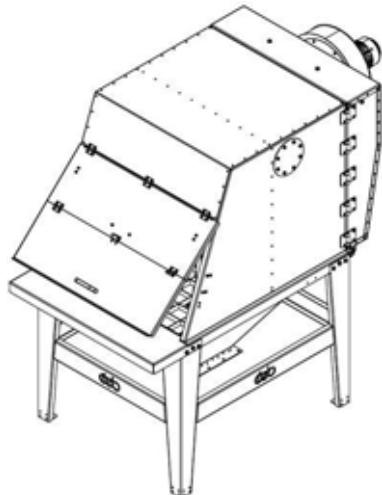
Code	Material	Price		
MBOS.095.430.X.1	AISI 430	\$19,748.82	Main unit with; * 0,75 kW fan * Bag inlet door with switch * 10 m ² filter with horizontally mounted elliptical bags * Filter control board * Hopper nominal 285 lt for MBOS.095, 360 lt for MBOS.125 together with leg * Hopper, Ø273mm outlet, without flange * KVM-30-MV-M01 vibrator on hopper is included	
MBOS.095.304.X.1	AISI 304	\$22,016.54		
MBOS.095.316.X.1	AISI 316	\$30,428.58		
MBOS.125.430.X.1	AISI 430	\$22,709.96		
MBOS.125.304.X.1	AISI 304	\$25,318.02		
MBOS.125.316.X.1	AISI 316	\$34,993.14		

PRICE DIFFERENCE FOR FAN OPTIONS

Code	Motor Power	Price	
FRSJ00012000	1,1 kW	\$2,604.42	* 230-400 V 50 Hz * IE3



FLANGE FOR BUTTERFLY VALVES				
Code	Ø Valve	Price AISI 430	Price AISI 304	Price AISI 316
SC.F.BV.250	BV.250	\$211.12	\$280.28	\$385.84

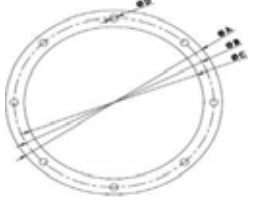

FLANGE FOR SLIDE VALVES				
Code	Ø Valve	Price AISI 430	Price AISI 304	Price AISI 316
SC.F.SVC.250	(SVC) 250	\$282.10	\$373.10	\$516.88

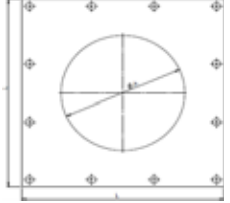

CONICAL ADAPTOR WITH ROUND FLANGES				
Code	ØB - ØA	Price AISI 430	Price AISI 304	Price AISI 316
SCS07007020	C200 - C250	\$232.96	\$309.40	\$425.88
SCS07007040	C250 - C300	\$314.86	\$416.78	\$576.94



FILTER ELEMENT & CAGE		
Code		Price
FE.E.S.520.1650.ST	520x1650 Elliptical Bag	\$138.32
FK.E.S.520.1650.1	Cage	\$198.38



VIBRATOR (MAX DISCOUNT 20%)					
Code	Revolution	Centrifugal Force	Power	Price	
KVM-30-MV-M01	3000	22	0,026	\$251.16	

1	2	3	4	5	6	7	8	9	10
LB	S	F	P	0	F	ST	0	1	1650

1	Loading Bellow
---	----------------

LB

2	Loading Type
---	--------------

S	Silobas loading
T	Open truck loading

3	Metal parts in contact with handled material
---	--

F	Galvanized
X	Stainless steel

4	Bellow material
---	-----------------

P	Polymer - PVC coated
K	Kevlar

5	Inner cone
---	------------

0	Excluded
C	Fe Carbon Steel
X	Stainless steel
H	Hardox

6	Filter
---	--------

00	Without Filter
F1	10m ² filter with 1,5 kW fan (Available for only type without inner cone)
F2	10m ² filter with 0,75 kW fan (Available for only type with inner cone)

7	Filter element
---	----------------

00	Without Filter
ST	Screwable Cartridge in Standard filtering Media
TF	Screwable Cartridge in Teflon Coated filtering Media

8	Bottom Closure Cone
---	---------------------

0	Excluded
1	Included

9	Electric panel
---	----------------

0	Excluded
1	Included

10	Stroke
----	--------

XXXX	Nominal XXXX mm
------	-----------------

LB FOR SILOBUS LOADING

*** SILOBUS LOADING
* DOUBLE CHUTE,
WITHOUT INNER CONE
* WITHOUT FILTER**

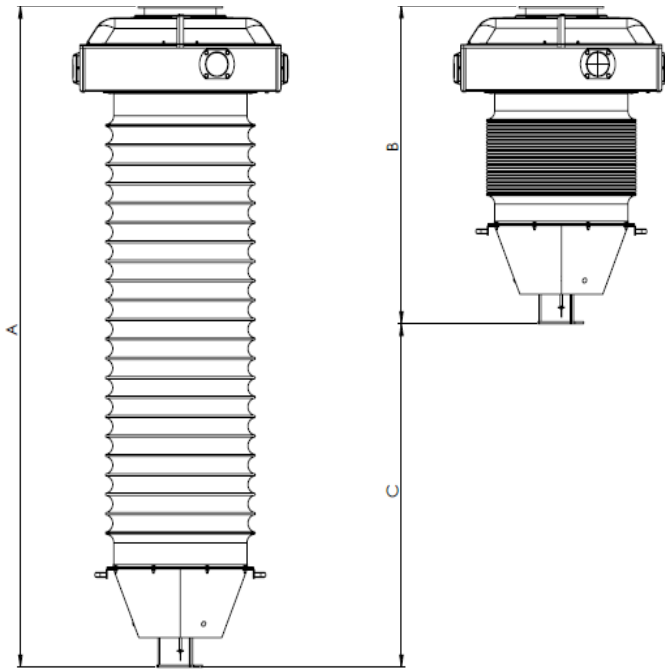

Code	Extended Length mm	Retracted Length mm	Stroke mm	Price	
LB.S.F.P.0.00.00.0.0.1650	*** 2.840	*** 1.190	*** 1.650	\$9,287.46	* Double chute, <i>without inner cone</i> * Material in contact with handled material made of <i>galvanized</i> * 220VAC Level indicator included * <i>Filter excluded</i>
LB.S.F.P.0.00.00.0.0.2500	*** 3.840	*** 1.340	*** 2.500	\$10,395.84	* Bottom closure cone excluded * Control panel excluded
Code	Extended Length mm	Retracted Length mm	Stroke mm	Price	
LB.S.X.P.0.00.00.0.0.1650	*** 2.840	*** 1.190	*** 1.650	\$12,352.34	* Double chute, <i>without inner cone</i> * Material in contact with handled material made of <i>AISI 304 stainless steel</i> * 220VAC Level indicator included * <i>Filter excluded</i>
LB.S.X.P.0.00.00.0.0.2500	*** 3.840	*** 1.340	*** 2.500	\$13,826.54	* Bottom closure cone excluded * Control panel excluded

***** If a bottom closure cone is requested, the lengths will be extended by +350mm**

PRICE DIFFERENCE FOR OPTIONS	
Description	Price
Control panel 220-380V 50Hz (with control button)	\$4,873.96
Level Indicator 24VAC & 110 VAC	\$100.10
Bottom Closure Cone-Rubber coated	\$2,600.78
Bottom Closure Cone-AISI 304	\$4,697.42

*** SILOBUS LOADING
* SINGLE CHUTE WITH
INNER CONE
* WITHOUT FILTER**

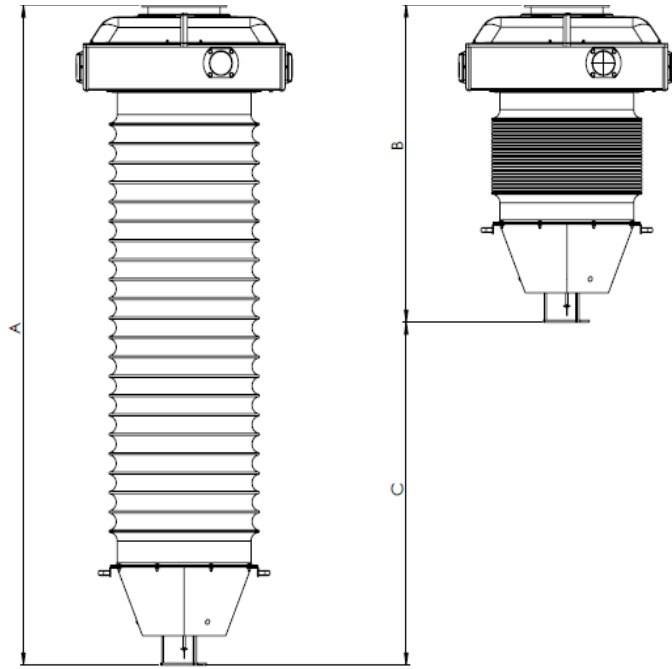

Code	Extended Length mm	Retracted Length mm	Stroke mm	Price	
LB.S.F.P.C.00.00.0.0.1500	*** 2.887	*** 1.385	*** 1.500	\$10,122.84	* Single chute, <i>with inner cone</i> * Material in contact with handled material made of <i>galvanized</i> * 220VAC Level indicator included * <i>Filter excluded</i>
LB.S.F.P.C.00.00.0.0.2250	*** 3.787	*** 1.535	*** 2.250	\$11,331.32	* Bottom closure cone excluded * Control panel excluded
Code	Extended Length mm	Retracted Length mm	Stroke mm	Price	
LB.S.X.P.X.00.00.0.0.1500	*** 2.887	*** 1.385	*** 1.500	\$13,464.36	* Single chute, <i>with inner cone</i> * Material in contact with handled material made of <i>AISI 304 stainless steel</i> * 220VAC Level indicator included * <i>Filter excluded</i>
LB.S.X.P.X.00.00.0.0.2250	*** 3.787	*** 1.535	*** 2.250	\$15,071.42	* Bottom closure cone excluded * Control panel excluded

***** If a bottom closure cone is requested, the lengths will be extended by +350mm**

PRICE DIFFERENCE FOR OPTIONS	
Description	Price
Control panel 220-380V 50Hz (with control button)	\$4,873.96
Level Indicator 24VAC & 110 VAC	\$100.10
Bottom Closure Cone-Rubber coated	\$2,600.78
Bottom Closure Cone-AISI 304	\$4,697.42

LB FOR SILOBUS LOADING WITH FILTER

*** SILOBUS LOADING
* DOUBLE CHUTE,
WITHOUT INNER CONE
* WITH FILTER**

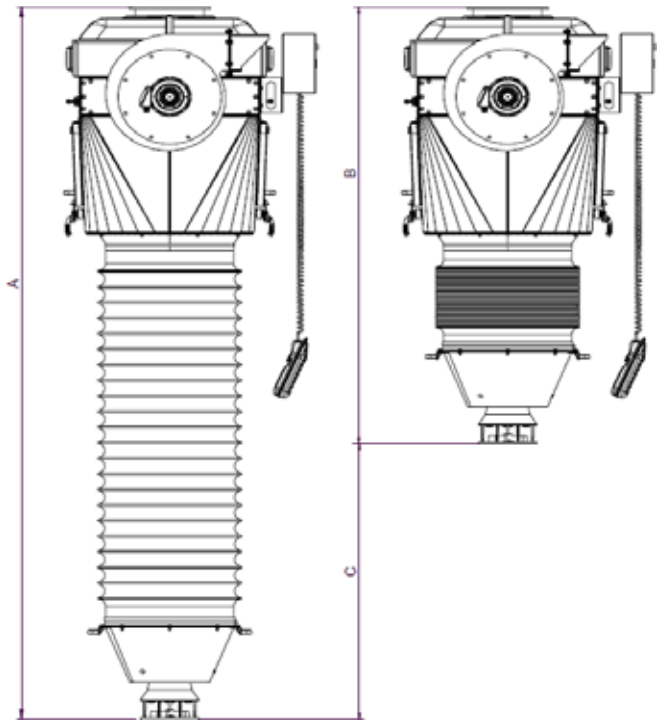

Code	Extended Length mm	Retracted Length mm	Stroke mm	Price	
LB.S.F.P.O.F1.ST.O.O.1650	*** 3.660	*** 2.010	*** 1.650	\$17,182.62	* Double chute, without inner cone * Material in contact with handled material made of galvanized * 220VAC Level indicator included * 10m² Filter with 1,5 kW fan included * Bottom closure cone excluded * Control panel excluded
LB.S.F.P.O.F1.ST.O.O.2500	*** 4.660	*** 2.160	*** 2.500	\$19,231.94	
Code	Extended Length mm	Retracted Length mm	Stroke mm	Price	
LB.S.X.P.O.F1.ST.O.O.1650	*** 3.660	*** 2.010	*** 1.650	\$22,851.92	* Double chute, without inner cone * Material in contact with handled material made of AISI 304 stainless steel * 220VAC Level indicator included * 10m² Filter with 1,5 kW fan included * Bottom closure cone excluded * Control panel excluded
LB.S.X.P.O.F1.ST.O.O.2500	*** 4.660	*** 2.160	*** 2.500	\$25,578.28	

***** If a bottom closure cone is requested, the lengths will be extended by +350mm**

PRICE DIFFERENCE FOR OPTIONS	
Description	Price
Control panel 220-380V 50Hz (with control button)	\$5,117.84
Level Indicator 24VAC & 110 VAC	\$100.10
Bottom Closure Cone-Rubber coated	\$2,600.78
Bottom Closure Cone-AISI 304	\$4,697.42
Teflon coated filter element	\$2,329.60

*** SILOBUS LOADING
* SINGLE CHUTE WITH
INNER CONE
* WITH FILTER**

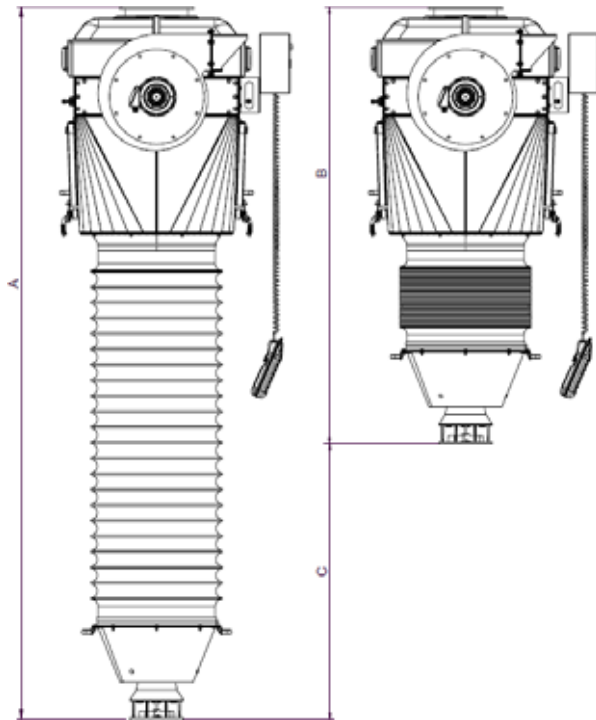

Code	Extended Length mm	Retracted Length mm	Stroke mm	Price	
LB.S.F.P.C..F2.ST.O.O.1500	*** 3.707	*** 2.205	*** 1.500	\$20,247.50	* Single chute, <i>with inner cone</i> * Material in contact with handled material made of <i>galvanized</i> * 220VAC Level indicator included * <i>10m² Filter with 0,75 kW fan included</i>
LB.S.F.P.C.F2.ST.O.O.2250	*** 4.607	*** 2.355	*** 2.250	\$22,662.64	* Bottom closure cone excluded * Control panel excluded
Code	Extended Length mm	Retracted Length mm	Stroke mm	Price	
LB.S.X.P.X.F2.ST.O.O.1500	*** 3.707	*** 2.205	*** 1.500	\$26,928.72	* Single chute, <i>with inner cone</i> * Material in contact with handled material made of <i>AISI 304 stainless steel</i> * 220VAC Level indicator included * <i>10m² Filter with 0,75 kW fan included</i>
LB.S.X.P.X.F2.ST.O.O.2250	*** 4.607	*** 2.355	*** 2.250	\$30,141.02	* Bottom closure cone excluded * Control panel excluded

***** If a bottom closure cone is requested, the lengths will be extended by +350mm**

PRICE DIFFERENCE FOR OPTIONS	
Description	Price
Control panel 220-380V 50Hz (with control button)	\$5,117.84
Level Indicator 24VAC & 110 VAC	\$100.10
Bottom Closure Cone-Rubber coated	\$2,600.78
Bottom Closure Cone-AISI 304	\$4,697.42
Teflon coated filter element	\$2,329.60

LB FOR OPEN TRUCK LOADING

*** OPEN TRUCK LOADING
* DOUBLE CHUTE,
WITHOUT INNER CONE
* WITHOUT FILTER**

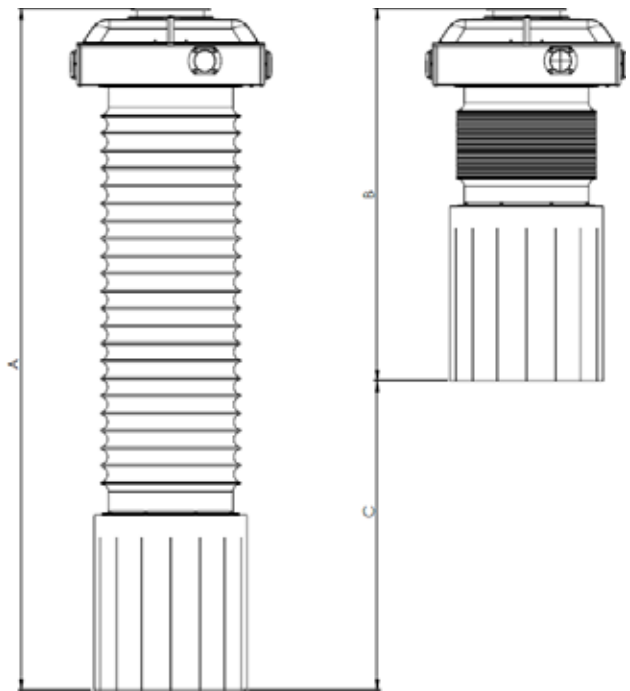

Code	Extended Length mm	Retracted Length mm	Stroke mm	Price	
LB.T.F.P.0.00.00.0.0.1650	*** 3.170	*** 1.520	*** 1.650	\$9,751.56	* Double chute, <i>without inner cone</i> * Material in contact with handled material made of <i>galvanized</i> * 220VAC Level indicator included * <i>Filter excluded</i>
LB.T.F.P.0.00.00.0.0.2500	*** 4.170	*** 1.670	*** 2.500	\$10,916.36	* Bottom closure cone excluded * Control panel excluded * With skirt
Code	Extended Length mm	Retracted Length mm	Stroke mm	Price	
LB.T.X.P.0.00.00.0.0.1650	*** 3.170	*** 1.520	*** 1.650	\$12,969.32	* Double chute, <i>without inner cone</i> * Material in contact with handled material made of <i>AISI 304 stainless steel</i> * 220VAC Level indicator included * <i>Filter excluded</i>
LB.T.X.P.0.00.00.0.0.2500	*** 4.170	*** 1.670	*** 2.500	\$14,518.14	* Bottom closure cone excluded * Control panel excluded * With skirt

***** If a bottom closure cone is requested, the lengths will be extended by +350mm**

PRICE DIFFERENCE FOR OPTIONS	
Description	Price
Control panel 220-380V 50Hz (with control button)	\$5,156.06
Level Indicator 24VAC & 110 VAC	\$100.10

*** OPEN TRUCK LOADING
* SINGLE CHUTE WITH
INNER CONE
* WITHOUT FILTER**

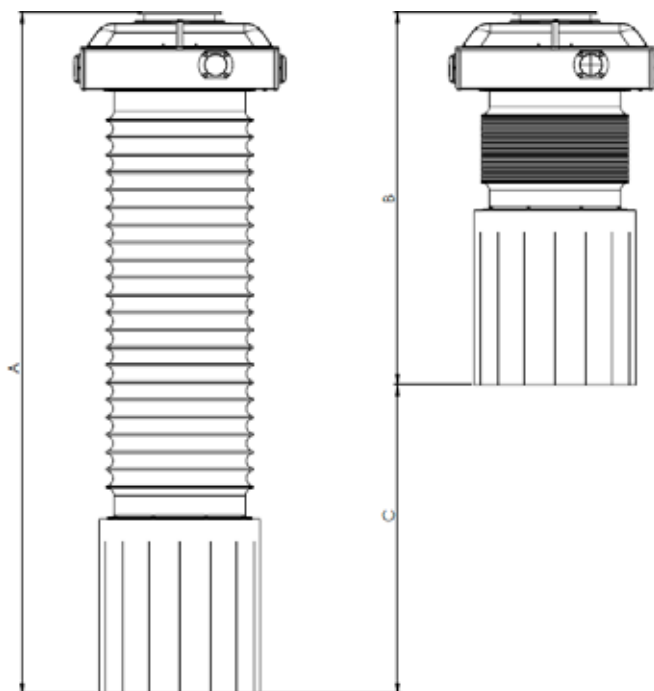

Code	Extended Length mm	Retracted Length mm	Stroke mm	Price	
LB.T.F.P.C.00.00.0.0.1500	*** 3.217	*** 1.715	*** 1.500	\$10,628.80	* Single chute, <i>with inner cone</i> * Material in contact with handled material made of <i>galvanized</i> * 220VAC Level indicator included * <i>Filter excluded</i>
LB.T.F.P.C.00.00.0.0.2250	*** 4.117	*** 1865	*** 2.250	\$11,897.34	* Bottom closure cone excluded * Control panel excluded * With skirt
Code	Extended Length mm	Retracted Length mm	Stroke mm	Price	
LB.T.X.P.X.00.00.0.0.1500	*** 3.217	*** 1.715	*** 1.500	\$14,137.76	* Single chute, <i>with inner cone</i> * Material in contact with handled material made of <i>AISI 304 stainless steel</i> * 220VAC Level indicator included * <i>Filter excluded</i>
LB.T.X.P.X.00.00.0.0.2250	*** 4.117	*** 1.865	*** 2.250	\$15,824.90	* Bottom closure cone excluded * Control panel excluded * With skirt

***** If a bottom closure cone is requested, the lengths will be extended by +350mm**

PRICE DIFFERENCE FOR OPTIONS	
Description	Price
Control panel 220-380V 50Hz (with control button)	\$5,156.06
Level Indicator 24VAC & 110 VAC	\$100.10

LB FOR OPEN TRUCK LOADING WITH FILTER

*** OPEN TRUCK LOADING
* DOUBLE CHUTE,
WITHOUT INNER CONE
* WITH FILTER**

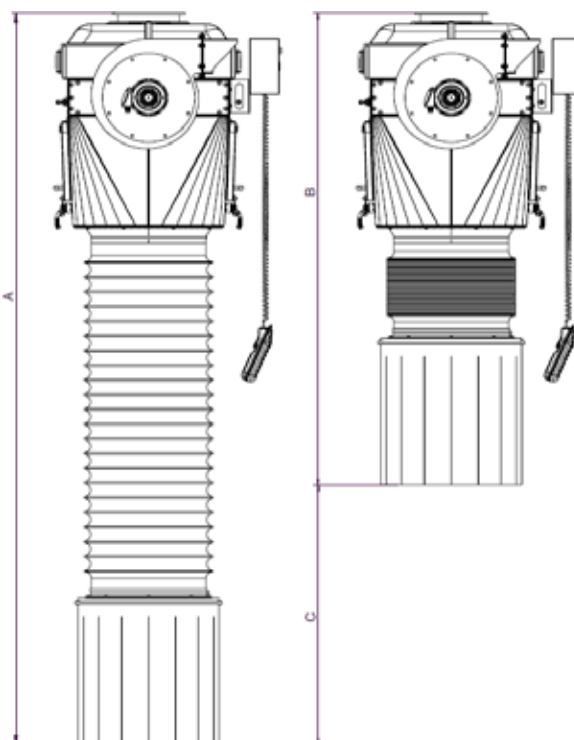

Code	Extended Length mm	Retracted Length mm	Stroke mm	Price	
LB.T.F.P.O.F1.ST.O.O.1650	*** 3.990	*** 2.340	*** 1.650	\$18,041.66	* Double chute, <i>without inner cone</i> * Material in contact with handled material made of <i>galvanized</i> * 220VAC Level indicator included * 10m² Filter with 1,5 kW fan included
LB.T.F.P.O.F1.ST.O.O.2500	*** 4.990	*** 2.490	*** 2.500	\$20,194.72	* Bottom closure cone excluded * Control panel excluded * With skirt
Code	Extended Length mm	Retracted Length mm	Stroke mm	Price	
LB.T.X.P.O.F1.ST.O.O.1650	*** 3.990	*** 2.340	*** 1.650	\$23,994.88	* Double chute, <i>without inner cone</i> * Material in contact with handled material made of <i>AISI 304 stainless steel</i> * 220VAC Level indicator included * 10m² Filter with 1,5 kW fan included
LB.T.X.P.O.F1.ST.O.O.2500	*** 4.990	*** 2.490	*** 2.500	\$26,857.74	* Bottom closure cone excluded * Control panel excluded * With skirt

***** If a bottom closure cone is requested, the lengths will be extended by +350mm**

PRICE DIFFERENCE FOR OPTIONS	
Description	Price
Control panel 220-380V 50Hz (with control button)	\$5,412.68
Level Indicator 24VAC & 110 VAC	\$100.10
Teflon coated filter element	\$2,329.60

*** OPEN TRUCK LOADING
* SINGLE CHUTE WITH
INNER CONE
* WITH FILTER**

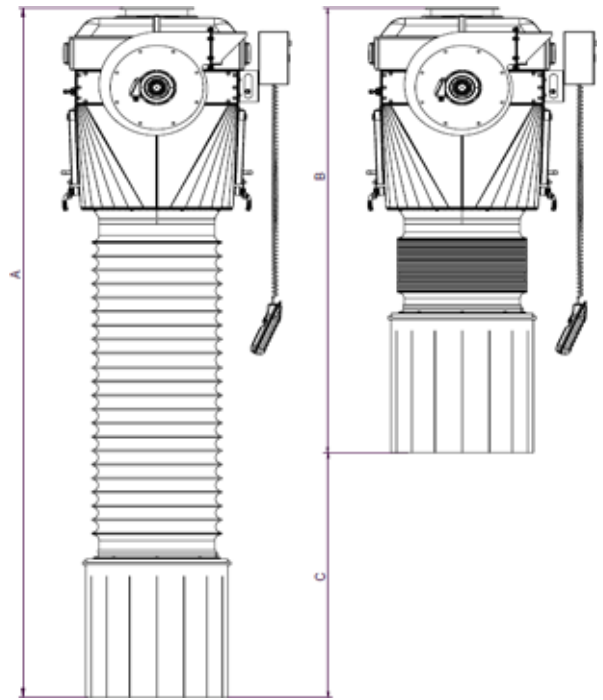





Code	Extended Length mm	Retracted Length mm	Stroke mm	Price	
LB.T.F.P.C.F2.ST.0.0.1500	*** 4.037	*** 2.535	*** 1.500	\$21,259.42	* Single chute, with inner cone * Material in contact with handled material made of galvanized * 220VAC Level indicator included * 10m² Filter with 0.75 kW fan included * Bottom closure cone excluded * Control panel excluded * With skirt
LB.T.F.P.C.F2.ST.0.0.2250	*** 4.937	*** 2.685	*** 2.250	\$23,796.50	
Code	Extended Length mm	Retracted Length mm	Stroke mm	Price	
LB.T.X.P.X.F2.ST.0.0.1500	*** 4.037	*** 2.535	*** 1.500	\$28,273.70	* Single chute, with inner cone * Material in contact with handled material made of AISI 304 stainless steel * 220VAC Level indicator included * 10m² Filter with 0,75 kW fan included * Bottom closure cone excluded * Control panel excluded * With skirt
LB.T.X.P.X.F2.ST.0.0.2250	*** 4.937	*** 2.685	*** 2.250	\$31,647.98	

***** If a bottom closure cone is requested, the lengths will be extended by +350mm**

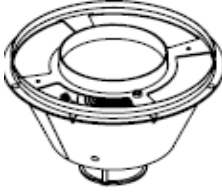
PRICE DIFFERENCE FOR OPTIONS	
Description	Price
Control panel 220-380V 50Hz (with control button)	\$5,412.68
Level Indicator 24VAC & 110 VAC	\$100.10
Teflon coated filter element	\$2,329.60

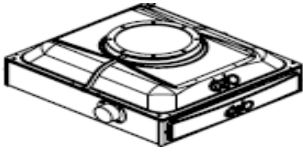
LB SPARE PARTS

Code	Description	Material	Price	
	Outlet Cone	Rubber coated	\$2,861.04	
		AISI 430 Stainless Steel	\$5,166.98	
LP220AC	Level Indicator		\$289.38	
	Upper Body - Drive Group		\$8,190.00	
FE.C.S.115.0500.ST	h:500 Cartridge		\$240.24	



Code	Price	
MTLS	\$125,125.00	<ul style="list-style-type: none"> * Hopper 2.000 It with FIBC cutting blade and grid * SCR/273/8500/HBR130/07/11 Screw Conveyor * LBFS12000 Loading Bellow for silobas loading * AIRFILL12 filter with 1,5kW fan and hopper * Hydraulic operated piston to adjust feeding height * Control panel for full operationals * With mobile frame equipped with 4 wheels

***** The system is designed for cement, please do not quote without cheking its suitability for different materials.**

PRICE DIFFERENCE FOR HBRD TYPE GEARBOXES				
Type	Gear Ratio	Electric Motor		Price
		Power	Size	
HBRD 130	1/7, 1/10	11-15 kW	160	+ \$121.94



PRICE DIFFERENCE FOR ELECTRIC MOTORS			
Power	Size	Price	380V-60Hz Extra Price
11 kW	160	Included	+ \$302.12
15 kW	160	+ \$687.96	+ \$364.00

Voltage & Frequency: Δ 400 / Y 690V 50 Hz \geq 4kW
Efficiency class: IE3
Protection class: IP 55
Insulation class: F (155 °C)
Flange: B5



TUNGSTEN CARBIDE COATING ON FLIGHT'S EDGES	
ØD mm	Price
273	\$112.84/m



Code	Price		
Remote Control	\$4,513.60		<p>FOR ONLY REMOTE CONTROL REQUEST; ASK FOR RECEIVER PHOTO & SERIAL NUMBER FROM CUSTOMER.</p>
Remote Control and Receiver	\$8,612.24		

A·E·L

ELECTRICAL - MECHANICAL - SCALES



CONTACT US

356 ROSEBANK ROAD
AVONDALE, AUCKLAND

(09) 828 5335

INFO@ALLWEST.CO.NZ